

PROPRIETARY NOTE

THIS SPECIFICATION IS THE PROPERTY OF AMELIN AND SHALL NOT BE REPRODUCED OR COPIED WITHOUT THE WRITTEN PERMISSION OF AMELIN AND MUST BE RETURNED TO AMELIN UPON ITS REQUEST



SPEC. NUMBER	PRODUCT GROUP	REV.	ISSUE DATE	PAGE
	TFT- LCD	P2	2018-03-01	1 OF 33

AML156FHM-N4G V3.0 Product Specification Rev.P2

BUYER	Lenovo
SUPPLIER	Shenzhen Amelin Electronic Technology Co., Ltd
FG-Code	AML156FHM-N4G V3.0

ITEM	BUYER SIGNATURE	DATE
_____	_____	_____
_____	_____	_____
_____	_____	_____

ITEM	SUPPLIER SIGNATURE	DATE
Prepared	_____	_____
Reviewed	_____	_____
Approved	_____	_____

PRODUCT GROUP	REV	ISSUE DATE	AMELIN
TFT- LCD PRODUCT	P2	2018-03-01	

SPEC. NUMBER	SPEC . TITLE	PAGE
	AML156FHM-N4G V3.0 Product Specification	2 OF 33

REVISION HISTORY

REV.	ECN No.	DESCRIPTION OF CHANGES	DATE	PREPARED
P0		Initial Release	2017-12-21	SHAOLINFEI
P1		Update EDID&PACKING	2018-1-25	SHAOLINFE
P2		Change MDL label size to 48*12mm	2018-03-01	SHAOLINFE

Contents

No.	Items	Page
	REVISION HISTORY	2
	CONTENTS	3
1.0	General Description	4
2.0	Absolute Maximum ratings	6
3.0	Electrical specifications.	7
4.0	Optical specifications.	10
5.0	Interface Connection	15
6.0	Signal Timing Specification	17
7.0	Input Signals, Display Colors & Gray Scale of Colors	19
8.0	Power Sequence	20
9.0	Connector description	21
10.0	Mechanical Characteristics	22
11.0	Reliability Test	23
12.0	Handling & Cautions.	23
13.0	Packing information	25
14.0	Product Label	27
15.0	Appendix	28
16.0	EDID Table	30

PRODUCT GROUP		REV	ISSUE DATE	AMELIN
TFT- LCD PRODUCT		P2	2018-03-01	
SPEC. NUMBER	SPEC. TITLE			PAGE
	AML156FHM-N4G V3.0 Product Specification			4 OF 33

1.0 GENERAL DESCRIPTION

1.1 Introduction

AML156FHM-N4G V3.0 is a color active matrix TFT LCD module using amorphous silicon TFT's (Thin Film Transistors) as an active switching devices. This module has a 15.6 inch diagonally measured active area with FHD resolutions (1920 horizontal by 1080 vertical pixel array). Each pixel is divided into RED, GREEN, BLUE dots which are arranged in vertical Stripe and this module can display 16.7M colors. The TFT-LCD panel used for this module is a low reflection and higher color type. Therefore, this module is suitable for Notebook PC. The LED Driver for back-light driving is built in this model.

All input signals are eDP interface compatible.

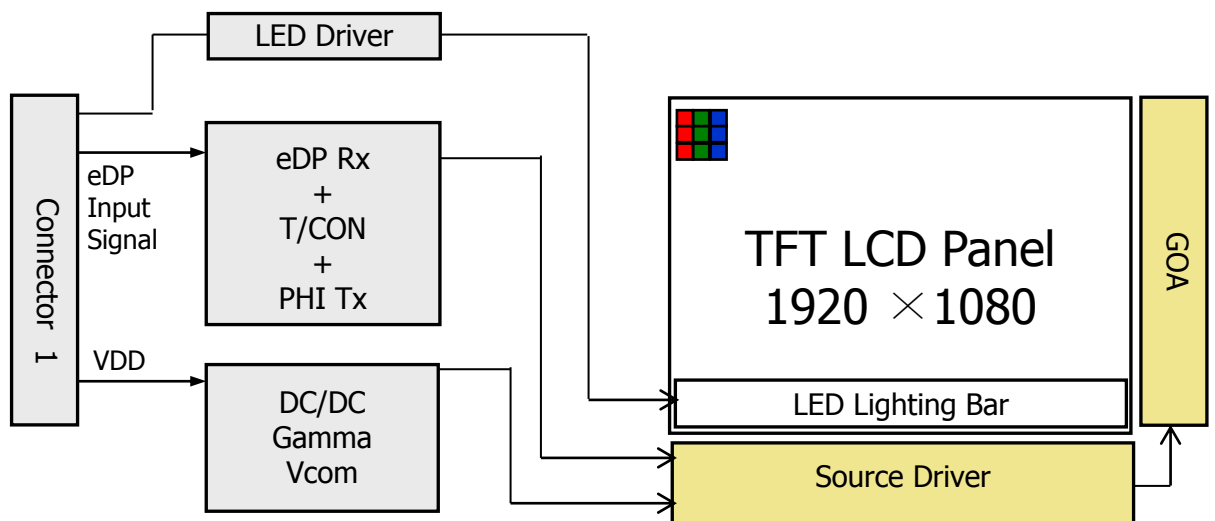

1.2 Features

- Support G-SYNC with Direct Driver
- Frame rate support range: 72Hz~144Hz;
- 4 lane Edp1.4 Interface with 5.4Gbps Link Rates
- Thin and light weight
- 8-bit color depth, display 16.7M colors
- Single LED Lighting Bar. (Bottom side/Horizontal Direction)
- Data enable signal mode
- Side Mounting Frame
- Green Product (RoHS & Halogen free product)
- On board LED Driving circuit
- Low driving voltage and low power consumption
- On board EDID chip

1.3 Application

- Note Book

1.4 General Specification

The followings are general specifications at the AML156FHM-N4G V3.0

<Table 1. LCD Module Specifications>

Parameter	Specification	Unit	Remarks
Active Area	344.16(H)*193.59(V)	Mm	
Number Of Pixels	1920(H)×1080(V)	Pixels	
Pixel Pitch	0.17925(H)×RGB×0.17925(V)	mm	
Pixel Arrangement	Pixels RGB stripe arrangement		
Display Mode	Normally Black		
Display Colors	16.7M(8bits)	Colors	
Display Mode	Normally Black		
Surface Treatment	上POL:高精细AG25 ; 下POL : APF		
Contrast Ratio	1200:1(typ.)		
Viewing Angle(CR>10)	89/89/89/89(typ.)	deg.	
Response Time	Tr+Tf=9 typ/12max.; GTG avg=3.8typ/5max	Ms	
Color Gamut	72%		
Brightness	300(typ)	cd/m2	
Brightness Uniformity	80% min for 5 points 60% min for 13 points		
Power Consumption	LCD: 2.4(Max.)(144Hz , Mosaic) BLU: 3.7W(Max.)	Watt	
Outline Dimension(LCM)	350.66(typ)*215.25(typ)*2.6(max)	mm	
Weight	280(max.)	gram	

PRODUCT GROUP		REV	ISSUE DATE	AMELIN
TFT- LCD PRODUCT		P2	2018-03-01	
SPEC. NUMBER	SPEC. TITLE			PAGE
	AML156FHM-N4G V3.0 Product Specification			6 OF 33

2.0 ABSOLUTE MAXIMUM RATINGS

The followings are maximum values which, if exceed, may cause faulty operation or damage to the unit. The operational and non-operational maximum voltage and current values are listed in Table 2.

< Table 2. Absolute Maximum Ratings >

Ta=25+/-2°C

Parameter	Symbol	Min.	Max.	Unit	Remarks
Power Supply Voltage	V _{DD}	-0.3	4.0	V	Note 1
Logic Supply Voltage	V _{IN}	V _{SS} -0.3	V _{DD} +0.3	V	
Operating Temperature	T _{OP}	0	+50	°C	Note 2
Storage Temperature	T _{ST}	-20	+60	°C	

Notes : 1. Permanent damage to the device may occur if maximum values are exceeded functional operation should be restricted to the condition described under normal operating conditions.

2. Temperature and relative humidity range are shown in the figure below.
 95 % RH Max. (40 °C ≥ Ta) Maximum wet - bulb temperature at 39 °C or less
 .(Ta > 40 °C) No condensation.

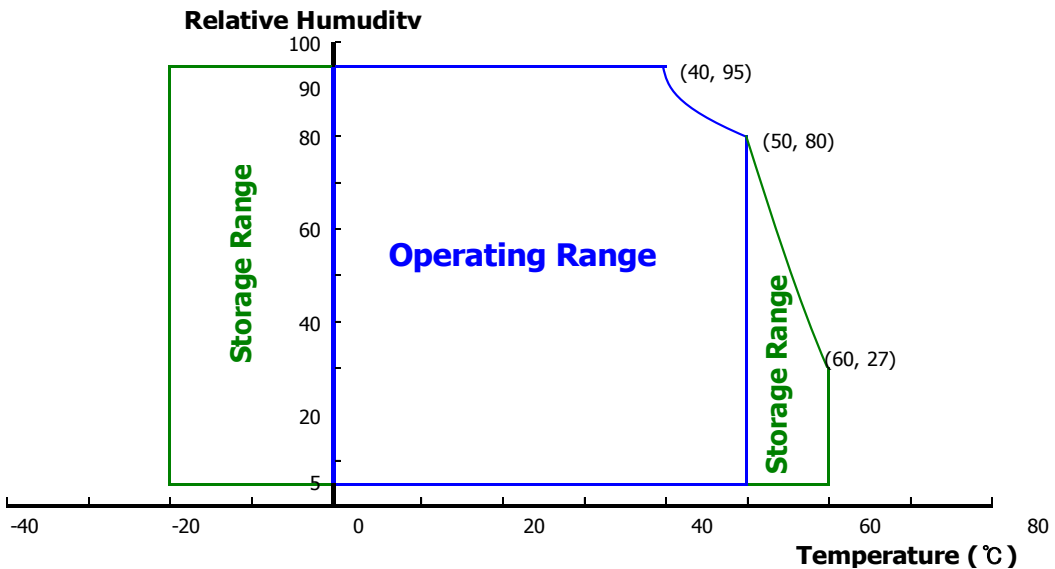

3.0 ELECTRICAL SPECIFICATIONS

3.1 Electrical Specifications

< Table 3. Electrical specifications >

[Ta =25±2 °C]

Parameter		Min.	Typ.	Max.	Unit	Remarks
Power Supply Voltage	V_{DD}	3.0	3.3	3.6	V	Note 1
Permissible Input Ripple Voltage	V_{RF}	-	-	100	mV	At $V_{DD} = 3.3V$
Power Supply Current	I_{DD}	-	727	1121	mA	Note 1
LX Current Limit	I_{LX}		2		A	
Positive-going Input Threshold Voltage	V_{IT+}	-	-	100	mV	$V_{cm} = 1.2V$ typ.
Negative-going Input Threshold Voltage	V_{IT-}	-100	-	-	mV	
Differential Input Voltage	V_{ID}	200	-	600	mV	
Power Consumption	P_D	-	2.4	3.7	W	Note 1
	P_{BL}	-		3.7	W	Note 2
	P_{total}	-	6.1	7.4	W	

Notes : 1. The supply voltage is measured and specified at the interface connector of LCM . The current draw and power consumption specified is for 3.3V at 25°C.

a) Typ : Mosaic pattern

b) Max : RGB pattern

2. Calculated value for reference ($V_{LED} \times I_{LED}$)

3.2 Back-Light Unit

< Table 4. LED Driving guideline specifications >

[Ta =25±2 °C]

Parameter		Min.	Typ.	Max.	Unit	Remarks
LED Forward Voltage	V_F	-	-	2.9	V	
LED Forward Current	I_F	-	22.5	-	mA	
LED Power Consumption	P_{LED}	-	-	3.7	W	Note 1
LED Life-Time	N/A	15,000	-	-	Hour	$I_F = 20.0mA$
Power supply voltage for LED Driver	V_{LED}	5	12	21	V	
EN Control Level	Backlight on	2.5	-	5.0	V	
	Backlight off	0	-	0.6	V	
PWM Control Level	PWM High Level	2.0	-	5.0	V	
	PWM Low Level	0	-	0.6	V	
PWM Control Frequency	F_{PWM}	200	-	10,000	Hz	
Duty Ratio	-	1	-	100	%	

Notes : 1. Power supply voltage 12V for LED Driver, Driver efficiency 87%,

Calculator Value for reference $I_F \times V_F \times 30 / 0.87 = P_{LED}$

2. The LED Life-time define as the estimated time to 50% degradation of initial luminous.

3.3 Pin assignment for LED Bar

Connector : MSK24022P10 (STM)

< Table5. Pin assignment for LED Bar >

Pin No	Symbol	Description	Remarks
1	VLED	LED Anode Power Supply	
2	VLED	LED Anode Power Supply	
3	VLED	LED Anode Power Supply	
4	NC	NC	
5	FB1	LED Cathode Power Supply	
6	FB2	LED Cathode Power Supply	
7	FB3	LED Cathode Power Supply	
8	FB4	LED Cathode Power Supply	
9	FB5	LED Cathode Power Supply	
10	FB6	LED Cathode Power Supply	

PRODUCT GROUP		REV	ISSUE DATE	
TFT- LCD PRODUCT		P2	2018-03-01	
SPEC. NUMBER	SPEC. TITLE			PAGE
	AML156FHM-N4G V3.0 Product Specification			10 OF 33

4.0 OPTICAL SPECIFICATIONS

4.1 Overview

The test of optical specifications shall be measured in a dark room (ambient luminance ≤ 1 lux and temperature = $25 \pm 2^\circ\text{C}$) with the equipment of Luminance meter system (Gonio meter system and TOPCON BM-5) and test unit shall be located at an approximate distance 50cm from the LCD surface at a viewing angle of θ and ϕ equal to 0° . We refer to $\theta\phi = 0$ ($=\theta 3$) as the 3 o' clock direction (the "right"), $\theta\phi = 90$ ($=\theta 12$) as the 12 O' clock direction ("upward"), $\theta\phi = 180$ ($=\theta 9$) as the 9 O' clock direction ("left") and $\theta\phi = 270$ ($=\theta 6$) as the 6 O' clock direction ("bottom"). While scanning θ and/or ϕ , the center of the measuring spot on the Display surface shall stay fixed.

4.2 Optical Specifications

< Table6. Optical Table >

Parameter		Symbol	Condition	Min.	Typ.	Max.	Unit	Remark
Viewing Angle range	Horizontal	Θ_3	CR > 10	80	89	-	Deg.	Note 1
		Θ_9		80	89	-	Deg.	
	Vertical	Θ_{12}		80	89	-	Deg.	
		Θ_6		80	89	-	Deg.	
Luminance Contrast ratio		CR	$\Theta = 0^\circ$	900	1200	-	-	Note 2
Luminance of White	Center Point	Y_w	$\Theta = 0^\circ$ ILED = 20mA	255	300	-	cd/m ²	Note 3
White Luminance uniformity	5 Points	ΔY_5		80%	-	-	-	Note 4
	13 Points	ΔY_{13}		60%	-	-	-	
White Chromaticity		x_w	$\Theta = 0^\circ$	-0.03	0.313	+0.03	-	Note 5
		y_w			0.329		-	
Reproduction of color	Red	x_R	$\Theta = 0^\circ$	-0.025	0.642	+0.025	-	-
		y_R			0.339		-	
	Green	x_G			0.316		-	
		y_G			0.606		-	
	Blue	x_B			0.153		-	
		y_B			0.050		-	
Gamut		-	$\Theta = 0^\circ$	67	72	-	%	NTSC
Response Time (Rising + Falling)		T_{RT}	Ta= 25° C $\Theta = 0^\circ$	-	9	12	ms	Note 6
Cross Talk		CT	$\Theta = 0^\circ$	-	-	2.0	%	Note 7

PRODUCT GROUP		REV	ISSUE DATE	
TFT- LCD PRODUCT		P2	2018-03-01	
SPEC. NUMBER	SPEC. TITLE			PAGE
	AML156FHM-N4G V3.0 Product Specification			11 OF 33

Notes :

1. Viewing angle is the angle at which the contrast ratio is greater than 10. The viewing angles are determined for the horizontal or 3, 9 o' clock direction and the vertical or 6, 12 o' clock direction with respect to the optical axis which is normal to the LCD surface (see FIGURE 1).

2. Contrast measurements shall be made at viewing angle of $\Theta = 0$ and at the center of the LCD surface. Luminance shall be measured with all pixels in the view field set first to white, then to the dark (black) state .
(see FIGURE 1) Luminance Contrast Ratio (CR) is defined mathematically.

$$CR = \frac{\text{Luminance when displaying a white raster}}{\text{Luminance when displaying a black raster}}$$

3. Center Luminance of white pattern on the LCD surface. Luminance shall be measured with all pixels in the view field set first to white. This measurement shall be taken at the locations shown in FIGURE 2 for a total of the measurements per display.

4. The White luminance uniformity on LCD surface is then expressed as : ΔY = Minimum Luminance of 5(or 13) points / Maximum Luminance of 5(or 13) points.
(see FIGURE 2 and FIGURE 3).

5. The color chromaticity coordinates specified in Table 5 shall be calculated from the spectral data measured with all pixels first in red, green, blue and white. Measurements shall be made at the center of the panel.

6. The electro-optical response time measurements shall be made as FIGURE 4 by switching the "data" input signal ON and OFF. The times needed for the luminance to change from 10% to 90% is T_r , and 90% to 10% is T_d .

7. Cross-Talk of one area of the LCD surface by another shall be measured by comparing the luminance (YA) of a 25mm diameter area, with all display pixels set to a gray level, to the luminance (YB) of that same area when any adjacent area is driven dark.
(See FIGURE 5).

PRODUCT GROUP		REV	ISSUE DATE	AMELIN
TFT- LCD PRODUCT		P2	2018-03-01	
SPEC. NUMBER	SPEC. TITLE			PAGE
	AML156FHM-N4G V3.0 Product Specification			12 OF 33

4.3 Optical measurements

Figure 1. Measurement Set Up

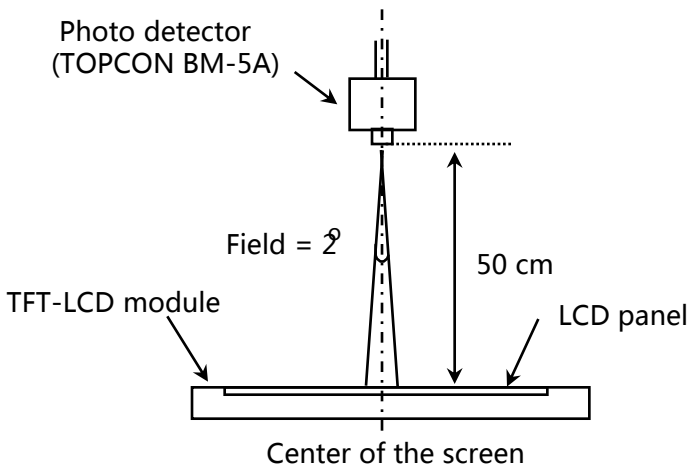

Optical characteristics measurement setup

Figure 2. White Luminance and Uniformity Measurement Locations (5 points)

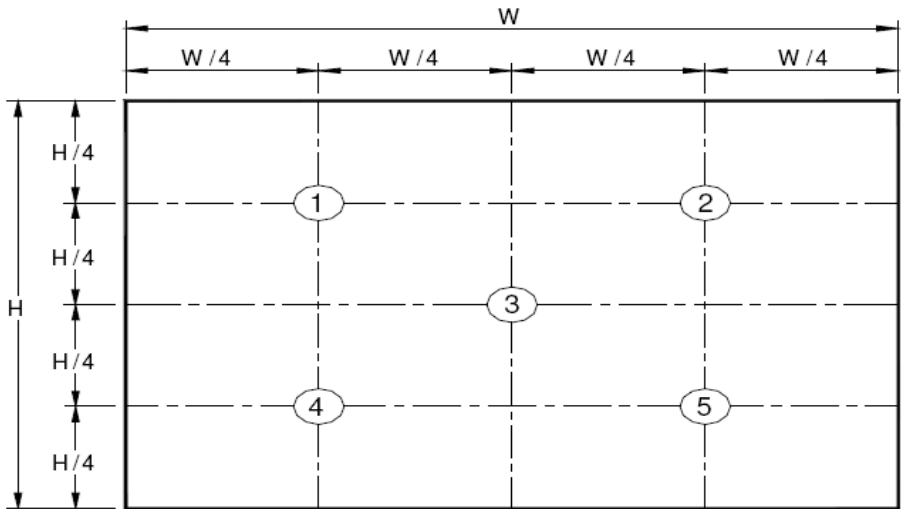

Center Luminance of white is defined as luminance values of center 5 points across the LCD surface. Luminance shall be measured with all pixels in the view field set first to white. This measurement shall be taken at the locations shown in FIGURE 2 for a total of the measurements per display.

PRODUCT GROUP		REV	ISSUE DATE	AMELIN
TFT- LCD PRODUCT		P2	2018-03-01	
SPEC. NUMBER	SPEC. TITLE			PAGE
	AML156FHM-N4G V3.0 Product Specification			13 OF 33

Figure 3. Uniformity Measurement Locations (13 points)

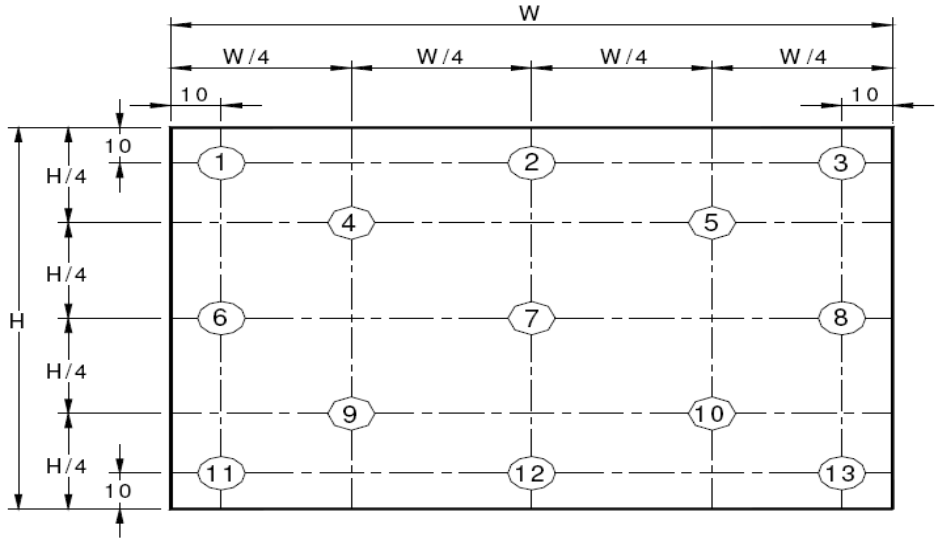

The White luminance uniformity on LCD surface is then expressed as : $\Delta Y5$ = Minimum Luminance of five points / Maximum Luminance of five points (see FIGURE 2) , $\Delta Y13$ = Minimum Luminance of 13 points /Maximum Luminance of 13 points (see FIGURE 3).

Response Time Testing

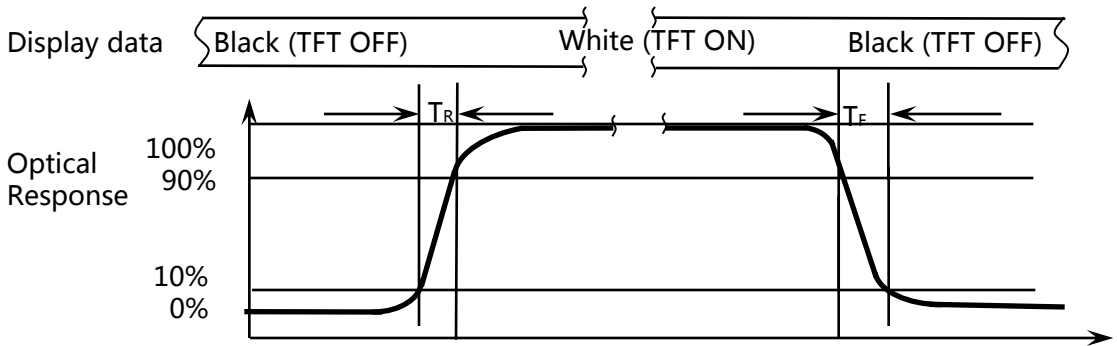

The electro-optical response time measurements shall be made as shown in FIGURE 4 by switching the "data" input signal ON and OFF. The times needed for the luminance to change from 10% to 90% is T_r and 90% to 10% is T_f .

PRODUCT GROUP		REV	ISSUE DATE	AMELIN
TFT- LCD PRODUCT		P2	2018-03-01	
SPEC. NUMBER	SPEC. TITLE			PAGE
	AML156FHM-N4G V3.0 Product Specification			14 OF 33

Figure 5. Cross Modulation Test Description

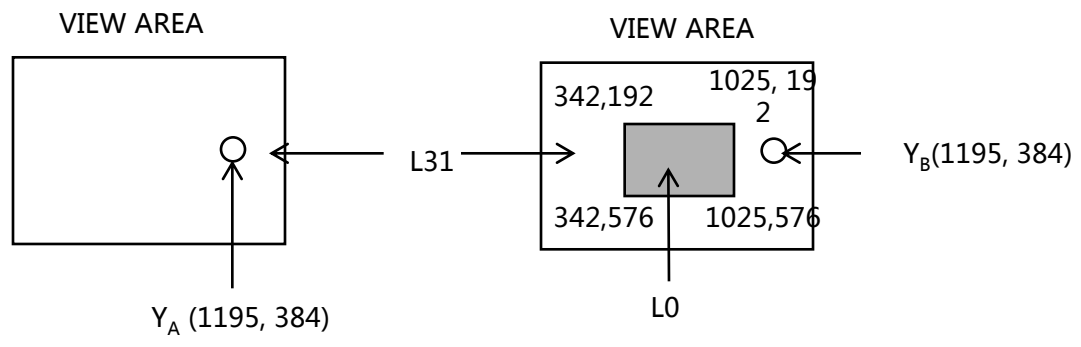

$$\text{Cross-Talk (\%)} = \left| \frac{Y_B - Y_A}{Y_A} \right| \times 100$$

Where:

Y_A = Initial luminance of measured area (cd/m²)

Y_B = Subsequent luminance of measured area (cd/m²)

The location measured will be exactly the same in both patterns

Cross-Talk of one area of the LCD surface by another shall be measured by comparing the luminance (YA) of a 25mm diameter area, with all display pixels set to a gray level, to the luminance (YB) of that same area when any adjacent area is driven dark (Refer to FIGURE 5).

5.0 INTERFACE CONNECTION.

5.1 Electrical Interface Connection

The electronics interface connector is STM. The mating connector part number is STM MSAK24025P40. The connector interface pin assignments are listed in Table 7.

<Table 7. Pin Assignments for the Interface Connector>

Terminal	Symbol	Functions
PIN No.	Symbol	Description
1	NC	NC
2	H_GND	eDP lane Up to 5.4G
3	Lane3_N	
4	Lane3_P	
5	H_GND	
6	Lane2_N	
7	Lane2_P	
8	H_GND	
9	Lane1_1N	
10	Lane1_1P	
11	H_GND	
12	Lane1_0N	
13	Lane1_0P	
14	H_GND	
15	AUX_CH_P	
16	AUX_CH_N	
17	H_GND	
18	LCD_VCC	
19	LCD_VCC	
20	LCD_VCC	
21	LCD_VCC	BIST (IN Port)
22	LCD_Self_Test(BIST)	
23	LCD_GND	Logic GND (Connect to GND in Module)
24	LCD_GND	
25	LCD_GND	
26	LCD_GND	
27	HPD	HPD (OUT Port 2.5V/3.3V)
28	BL_GND	BLU GND (Connect to GND in Module)
29	BL_GND	
30	BL_GND	
31	BL_GND	
32	BL_ENABLE	IN Port
33	BL_PWM	IN Port
34	H_sync	H_sync (OUT Port)
35	NC	NC
36	BL_PWR	BLU Power (5~21V)
37	BL_PWR	
38	BL_PWR	
39	BL_PWR	
40	Color Engine	NC

5.2. eDP Interface

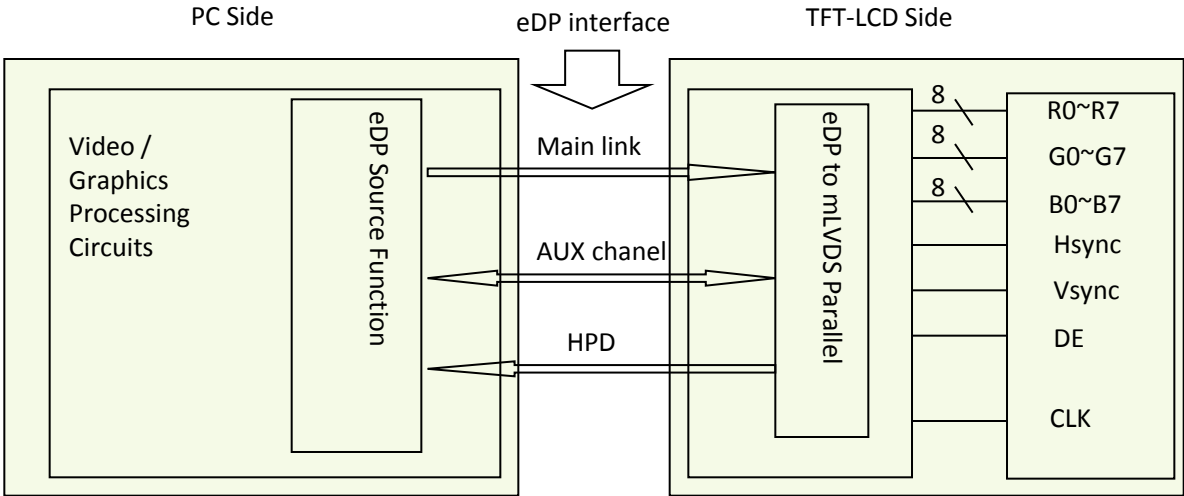

Note. Transmitter : Novatek NT71870. Transmitter is not contained in Module.

5.3.eDP Input signal

Lane 0	Lane 1
R0-7:0	R1-7:0
G0-7:0	G1-7:0
B0-7:0	B1-7:0
R2-7:0	R3-7:0
G2-7:0	G3-7:0
B2-7:0	B3-7:0
R4-7:0	R5-7:0
G4-7:0	G5-7:0
B4-7:0	B5-7:0

6.0 SIGNAL TIMING SPECIFICATION

6.1 Timing Parameters

Item		Symbols	Min	Typ	Max	Unit
Clock	Frequency	1/Tc	171.03	342.05		MHz
	High Time	Tch	-	4/7Tc	-	Tc
	Low Time	Tcl	-	3/7Tc	-	Tc
Frame Period		Tv	-	2284	-	lines
			72	144	144	Hz
			13.9	6.9	6.9	ms
Vertical Display Period		Tvd	-	1080	-	lines
One line Scanning Period		Th	-	2080	-	clocks
Horizontal Display Period		Thd	-	1920	-	clocks

Note*: This Module can support low frame refresh rate 60Hz

PRODUCT GROUP		REV	ISSUE DATE	AMELIN
TFT- LCD PRODUCT		P2	2018-03-01	
SPEC. NUMBER	SPEC. TITLE			PAGE
	AML156FHM-N4G V3.0 Product Specification			18 OF 33

6.2 eDP Rx Interface Timing Parameter

The specification of the eDP Rx interface timing parameter is shown in Table 8.

<Table 9. eDP Rx Interface Timing Specification>

Item	Symbol	Min	Typ	Max	Unit	Remark
Spread spectrum clock	ssc		0.5		%	
Differential peak-to-peak input voltage at package pins	VRX-DIFFp-p	70	-	-	mV	
Rx input DC common mode voltage	VRX_DC_CM	-	GND	-	V	
Differential termination resistance	RRX-DIFF	80	100	120	Ω	
Single-ended termination resistance	RRX-SE	40	-	60	Ω	
Rx short circuit current limit	IRX_SHORT	-	-	50	mA	
Intra-pair skew at Rx package pins (HBR) RX intra-pair skew tolerance at HBR	LRX_SKEW_INTRA_PAIR	-	-	150	ps	

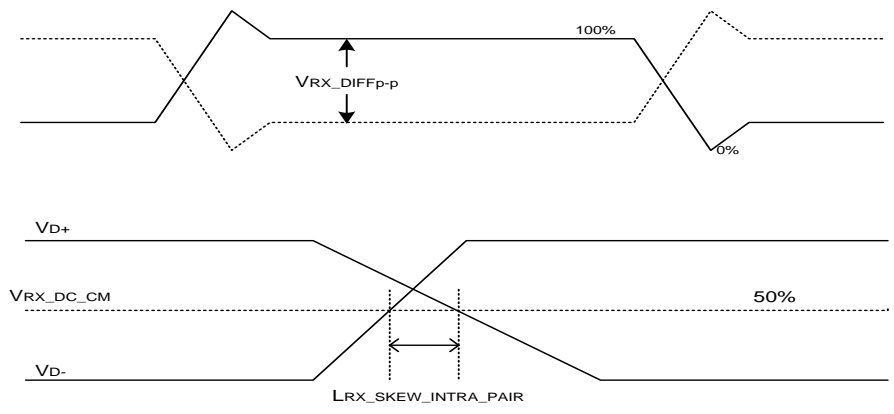

7.0 INPUT SIGNALS, BASIC DISPLAY COLORS & GRAY SCALE OF COLORS

	Colors & Gray scale	Data signal																							
		R0	R1	R2	R3	R4	R5	R6	R7	G0	G1	G2	G3	G4	G5	G6	G7	B0	B1	B2	B3	B4	B5	B6	B7
Basic colors	Black	0	0	0	0	0	0	0	0	0	0	0	0	0	0	0	0	0	0	0	0	0	0	0	0
	Blue	0	0	0	0	0	0	0	0	0	0	0	0	0	0	0	0	1	1	1	1	1	1	1	1
	Green	0	0	0	0	0	0	0	0	1	1	1	1	1	1	1	1	0	0	0	0	0	0	0	0
	Light Blue	0	0	0	0	0	0	0	0	1	1	1	1	1	1	1	1	1	1	1	1	1	1	1	1
	Red	1	1	1	1	1	1	1	1	0	0	0	0	0	0	0	0	0	0	0	0	0	0	0	0
	Purple	1	1	1	1	1	1	1	1	0	0	0	0	0	0	0	0	1	1	1	1	1	1	1	1
	Yellow	1	1	1	1	1	1	1	1	1	1	1	1	1	1	1	1	0	0	0	0	0	0	0	0
	White	1	1	1	1	1	1	1	1	1	1	1	1	1	1	1	1	1	1	1	1	1	1	1	1
Gray scale of Red	Black	0	0	0	0	0	0	0	0	0	0	0	0	0	0	0	0	0	0	0	0	0	0	0	0
	△	1	0	0	0	0	0	0	0	0	0	0	0	0	0	0	0	0	0	0	0	0	0	0	0
	Darker	0	1	0	0	0	0	0	0	0	0	0	0	0	0	0	0	0	0	0	0	0	0	0	0
	△	↑							↑							↑									
	▽	↓							↓							↓									
	Brighter	1	0	1	1	1	1	1	1	0	0	0	0	0	0	0	0	0	0	0	0	0	0	0	0
	▽	0	1	1	1	1	1	1	1	0	0	0	0	0	0	0	0	0	0	0	0	0	0	0	0
Red	1	1	1	1	1	1	1	1	0	0	0	0	0	0	0	0	0	0	0	0	0	0	0	0	
Gray scale of Green	Black	0	0	0	0	0	0	0	0	0	0	0	0	0	0	0	0	0	0	0	0	0	0	0	0
	△	0	0	0	0	0	0	0	0	1	0	0	0	0	0	0	0	0	0	0	0	0	0	0	0
	Darker	0	0	0	0	0	0	0	0	0	1	0	0	0	0	0	0	0	0	0	0	0	0	0	0
	△	↑							↑							↑									
	▽	↓							↓							↓									
	Brighter	0	0	0	0	0	0	0	0	1	0	1	1	1	1	1	1	0	0	0	0	0	0	0	0
	▽	0	0	0	0	0	0	0	0	0	1	1	1	1	1	1	1	0	0	0	0	0	0	0	0
Green	0	0	0	0	0	0	0	0	1	1	1	1	1	1	1	1	0	0	0	0	0	0	0	0	
Gray scale of Blue	Black	0	0	0	0	0	0	0	0	0	0	0	0	0	0	0	0	0	0	0	0	0	0	0	0
	△	0	0	0	0	0	0	0	0	0	0	0	0	0	0	0	0	1	0	0	0	0	0	0	0
	Darker	0	0	0	0	0	0	0	0	0	0	0	0	0	0	0	0	0	1	0	0	0	0	0	0
	△	↑							↑							↑									
	▽	↓							↓							↓									
	Brighter	0	0	0	0	0	0	0	0	0	0	0	0	0	0	0	0	1	0	1	1	1	1	1	1
	▽	0	0	0	0	0	0	0	0	0	0	0	0	0	0	0	0	0	1	1	1	1	1	1	1
Blue	0	0	0	0	0	0	0	0	0	0	0	0	0	0	0	0	1	1	1	1	1	1	1	1	
Gray scale of White & Black	Black	0	0	0	0	0	0	0	0	0	0	0	0	0	0	0	0	0	0	0	0	0	0	0	0
	△	1	0	0	0	0	0	0	0	1	0	0	0	0	0	0	0	1	0	0	0	0	0	0	0
	Darker	0	1	0	0	0	0	0	0	0	1	0	0	0	0	0	0	0	1	0	0	0	0	0	0
	△	↑							↑							↑									
	▽	↓							↓							↓									
	Brighter	1	0	1	1	1	1	1	1	1	0	1	1	1	1	1	1	1	0	1	1	1	1	1	1
	▽	0	1	1	1	1	1	1	1	0	1	1	1	1	1	1	1	0	1	1	1	1	1	1	1
White	1	1	1	1	1	1	1	1	1	1	1	1	1	1	1	1	1	1	1	1	1	1	1	1	

8.0 POWER SEQUENCE

To prevent a latch-up or DC operation of the LCD module, the power on/off sequence shall be as shown in below

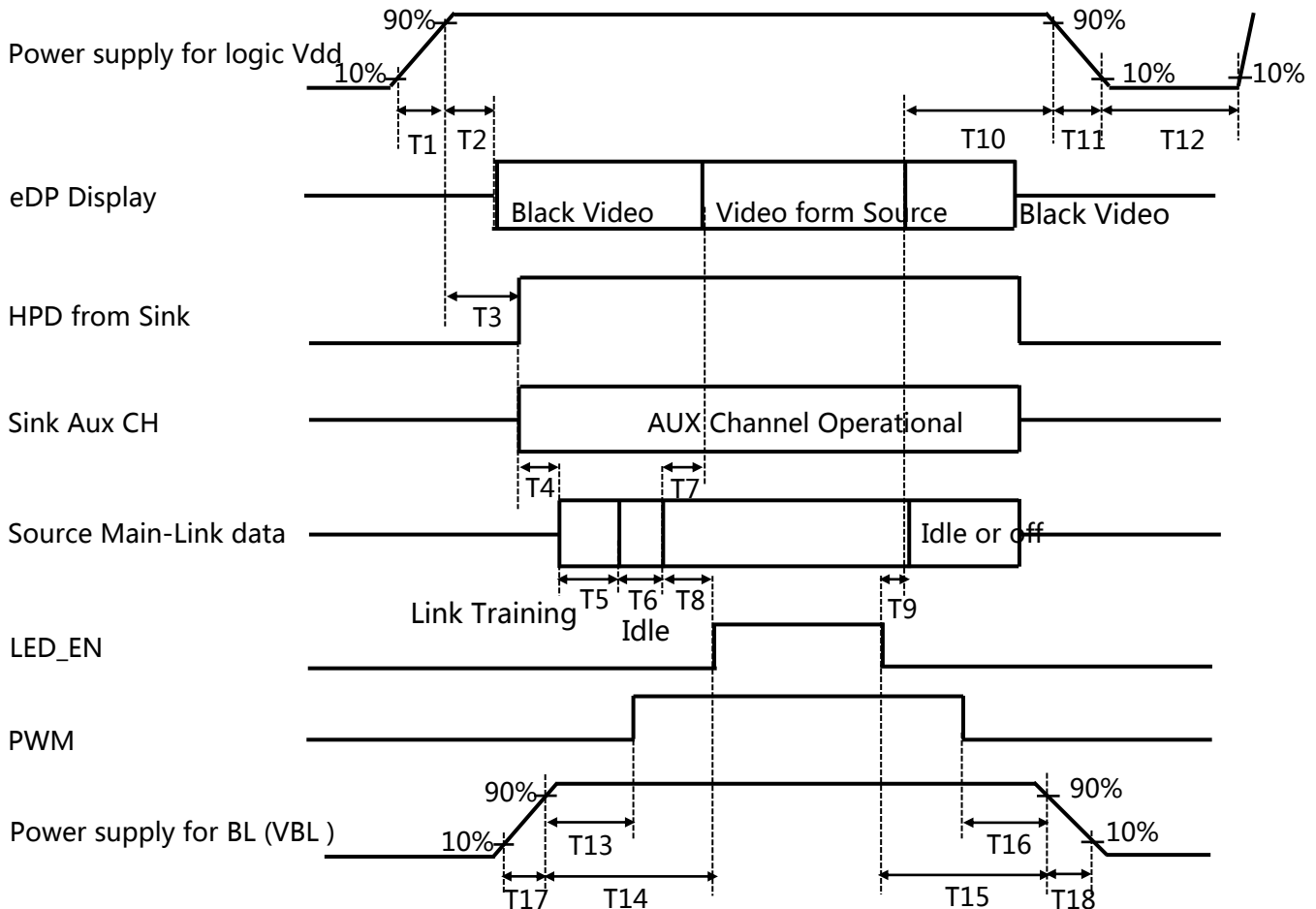

- 0.5ms ≤ T1 ≤ 10 ms
- 0ms ≤ T2 ≤ 200 ms
- 0ms ≤ T3 ≤ 200 ms
- 0ms ≤ T13
- 0ms ≤ T14
- 0ms ≤ T17
- 80ms ≤ T8
- 0ms ≤ T7 ≤ 50ms
- 0ms ≤ T10 ≤ 500 ms
- 0.5ms ≤ T11 ≤ 10 ms
- 500ms ≤ T12
- 0ms ≤ T15
- 0ms ≤ T16
- 0ms ≤ T18

Notes:

1. When the power supply VDD is 0V, keep the level of input signals on the low or keep high impedance.
2. Do not keep the interface signal high impedance when power is on. Back Light must be turn on after power for logic and interface signal are valid.

PRODUCT GROUP		REV	ISSUE DATE	
TFT- LCD PRODUCT		P2	2018-03-01	
SPEC. NUMBER	SPEC. TITLE			PAGE
	AML156FHM-N4G V3.0 Product Specification			21 OF 33

9.0 Connector Description

Physical interface is described as for the connector on LCM. These connectors are capable of accommodating the following signals and will be following components.

9.1 TFT LCD Module

Connector Name /Description	For Signal Connector
Manufacturer	STM
Type/ Part Number	MSAK24025P40
Mating housing/ Part Number	I-PEX 20454-030T

PRODUCT GROUP		REV	ISSUE DATE	
TFT- LCD PRODUCT		P2	2018-03-01	
SPEC. NUMBER	SPEC. TITLE			PAGE
	AML156FHM-N4G V3.0 Product Specification			22 OF 33

10.0 MECHANICAL CHARACTERISTICS

10.1 Dimensional Requirements

FIGURE 6 shows mechanical outlines for the model AML156FHM-N4G v3.0. Other parameters are shown in Table 9.

<Table 10. Dimensional Parameters>

Parameter	Specification	Unit
Active Area	344.16(H) × 193.59(V)	mm
Number of pixels	1920(H) × 1080(V)	
Pixel pitch	0.17925(H) × 0.17925(V)	mm
Pixel arrangement	RGB Vertical stripe	
Display colors	16.7M	
Display mode	HADS	
Dimensional outline	350.66(TYP)*215.25(TYP)*2.6(MAX)	mm
Weight	280Max	gram
Back Light	Connector :MSK24022P10D	
	6P*8S	

10.2 Mounting

See FIGURE 6.

10.3 Glare and Polarizer Hardness.

The surface of the LCD has a glare coating to maximize readability and hard coating to reduce scratching.

10.4 Light Leakage

There shall not be visible light from the back-lighting system around the edges of the screen as seen from a distance 50cm from the screen with an overhead light level of 350lux.

PRODUCT GROUP		REV	ISSUE DATE	
TFT- LCD PRODUCT		P2	2018-03-01	
SPEC. NUMBER	SPEC. TITLE			PAGE
	AML156FHM-N4G V3.0 Product Specification			23 OF 33

11.0 RELIABILITY TEST

The Reliability test items and its conditions are shown in below.

<Table 11. Reliability test>

No	Test Items	Conditions
1	High temperature storage test	Ta = 70 °C, 240 hrs
2	Low temperature storage test	Ta = -30 °C, 240 hrs
3	High temperature/High humidity Storage	Ta = 60 °C, 90%RH, 240 hrs
4	High temperature operation test	Ta = 60 °C, 240 hrs
5	Low temperature operation test	Ta = -10 °C, 240 hrs
6	Thermal Shock Storage	Ta = -30 °C ↔ 70 °C (0.5 hr), 27 cycle
7	Package Drop test	Height: 60cm, 1 corner, 3 edges, 6 surfaces: 1 time for each direction
8	Shock test (non-operating)	220G, 2ms, Half sine ±X, ±Y, ±Z
9	Package Vibration test	Frequency range: 10-55Hz, stroke:1.5mm, swep time: 1 minute, test period: 2 hours for each direction of X, Y, Z
10	Electro-static discharge test	Power OFF: Air discharged +/- 15kV Criteria C Contact discharged +/- 8kV Criteria C Power ON: Air discharged +/- 10kV Criteria B Contact discharged +/- 6kV Criteria B

12.0 HANDLING & CAUTIONS

(1) Cautions when taking out the module

- Pick the pouch only, when taking out module from a shipping package.

(2) Cautions for handling the module

- As the electrostatic discharges may break the LCD module, handle the LCD module with care. Peel a protection sheet off from the LCD panel surface as slowly as possible.
- As the LCD panel and back - light element are made from fragile glass material, impulse and pressure to the LCD module should be avoided.
- As the surface of the polarizer is very soft and easily scratched, use a soft dry cloth without chemicals for cleaning.

PRODUCT GROUP		REV	ISSUE DATE	
TFT- LCD PRODUCT		P2	2018-03-01	
SPEC. NUMBER	SPEC. TITLE		PAGE	
	AML156FHM-N4G V3.0 Product Specification		24 OF 33	

(4) Cautions for the atmosphere

- Dew drop atmosphere should be avoided.
- Do not store and/or operate the LCD module in a high temperature and/or humidity atmosphere. Storage in an electro-conductive polymer packing pouch and under relatively low temperature atmosphere is recommended.

(5) Cautions for the module characteristics

- Do not apply fixed pattern data signal to the LCD module at product aging.
- Applying fixed pattern for a long time may cause image sticking.

(6) Other cautions

- Do not disassemble and/or re-assemble LCD module.
- Do not re-adjust variable resistor or switch etc.
- When returning the module for repair or etc., Please pack the module not to be broken.

We recommend to use the original shipping packages.

PRODUCT GROUP		REV	ISSUE DATE	AMELIN
TFT- LCD PRODUCT		P2	2018-03-01	
SPEC. NUMBER	SPEC. TITLE			PAGE
	AML156FHM-N4G V3.0 Product Specification			25 OF 33

13.0 PACKING INFORMATION(产品形态 :)

Packing procedure:

- 将 1pcs MDL 平放入Tray, CF 侧向上放置;
- 产品上放置一层EPE Spacer

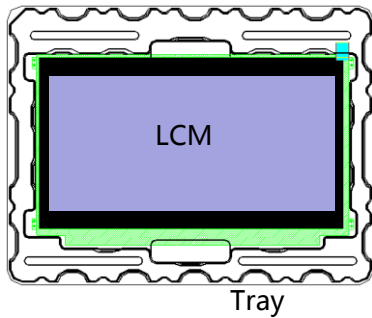

- 将26pcs PET Tray 平放入PE Bag 顶部1pcs 空Tray
- Tray 不旋转码放

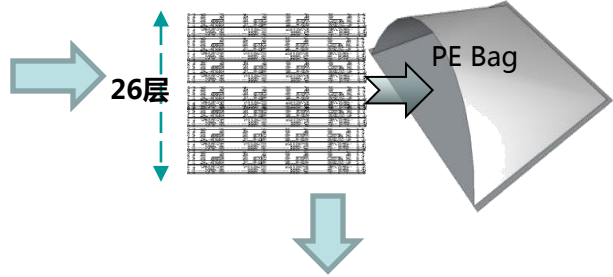

- 每个Pallet上放3层Box 1层4箱,共计12ea Box
- Pallet外进行缠膜包装
- 容量: 300pcs/Pallet

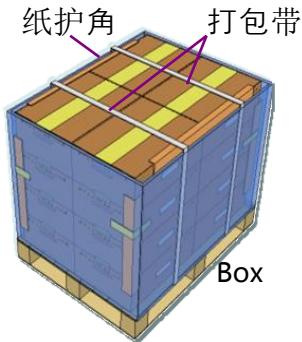

- 将PET Tray堆码后平放入Inner Box 上下放置EPE Cover
- 容量 : 25pcs/Inner Box

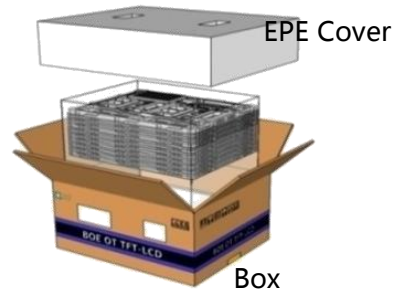

13.1 Packing Note(产品形态 : LCM)

- Box Dimension: 500mm(W) x 400mm(D) x 300mm(H)
- Package Quantity in one Box: 25pcs

PRODUCT GROUP

REV

ISSUE DATE

AMELIN

TFT- LCD PRODUCT

P2

2018-03-01

SPEC. NUMBER

SPEC. TITLE

PAGE

AML156FHM-N4G V3.0 Product Specification

26 OF 33

13.2 Box label (产品形态： LCM)

- Label Size :115mm*80mm
- Contents
 1. FG-CODE : AML156FHM-N4G V3.0
 2. Box 包装数量
 3. Box ID, 编码规则如下
 4. Box Packing 日期
 5. 客户料号 : 5D10R00685

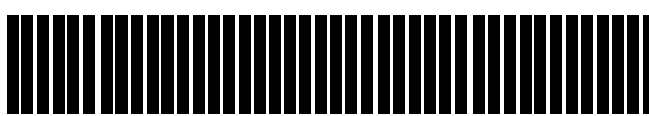
MODEL: AML156FHM-N4G V3.0 ①	QTY: 25 ②
SERIAL NO: XXXXXXXXXXXXX ③	DATE: 20XX . XX ④
	
XXXXX-XXXXXXXXX ⑤	xxxx

序号号	1	2	3	4	5	6	7	8	9	10	11	12	13
代 码	X	X	S	3	1	5	B	0	0	0	1	H	D
描 述	GBN代码		等 级	B3	年份		月	Rev	序列号				

PRODUCT GROUP		REV	ISSUE DATE	AMELIN
TFT- LCD PRODUCT		P2	2018-03-01	
SPEC. NUMBER	SPEC. TITLE			PAGE
	AML156FHM-N4G V3.0 Product Specification			27 OF 33

14.0 Product Label

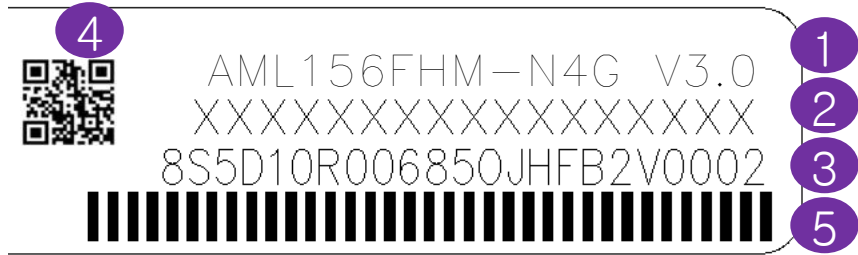

标签贴付于产品背面左下角
 标签尺寸: 48mm × 12mm
 物料编号 : 44-9231007

1. FG-CODE: AML156FHM-N4G V3.0
2. MDL ID
3. PPID
4. PPID对应二维码
5. MDL ID对应条形码

MDL ID 编码规则

序列号	1	2	3	4	5	6	7	8	9	10	11	12	13	14	15	16	17
代码	X	X	P	3	1	2	7	X	X	X	X	0	0	1	E	E	J
描述	GBN代码		等级	B3	年份	月	FG Code后四位				序列号						

PRODUCT GROUP		REV	ISSUE DATE	AMELIN
TFT- LCD PRODUCT		P2	2018-03-01	
SPEC. NUMBER	SPEC. TITLE			PAGE
	AML156FHM-N4G V3.0 Product Specification			28 OF 33

15.0 APPENDIX

Mechanical Drawing
Drawing Attachment: Front

NOTE
1. 弯曲度 ≤ 0.5mm
2. Halogen Free & ROHS & REACH

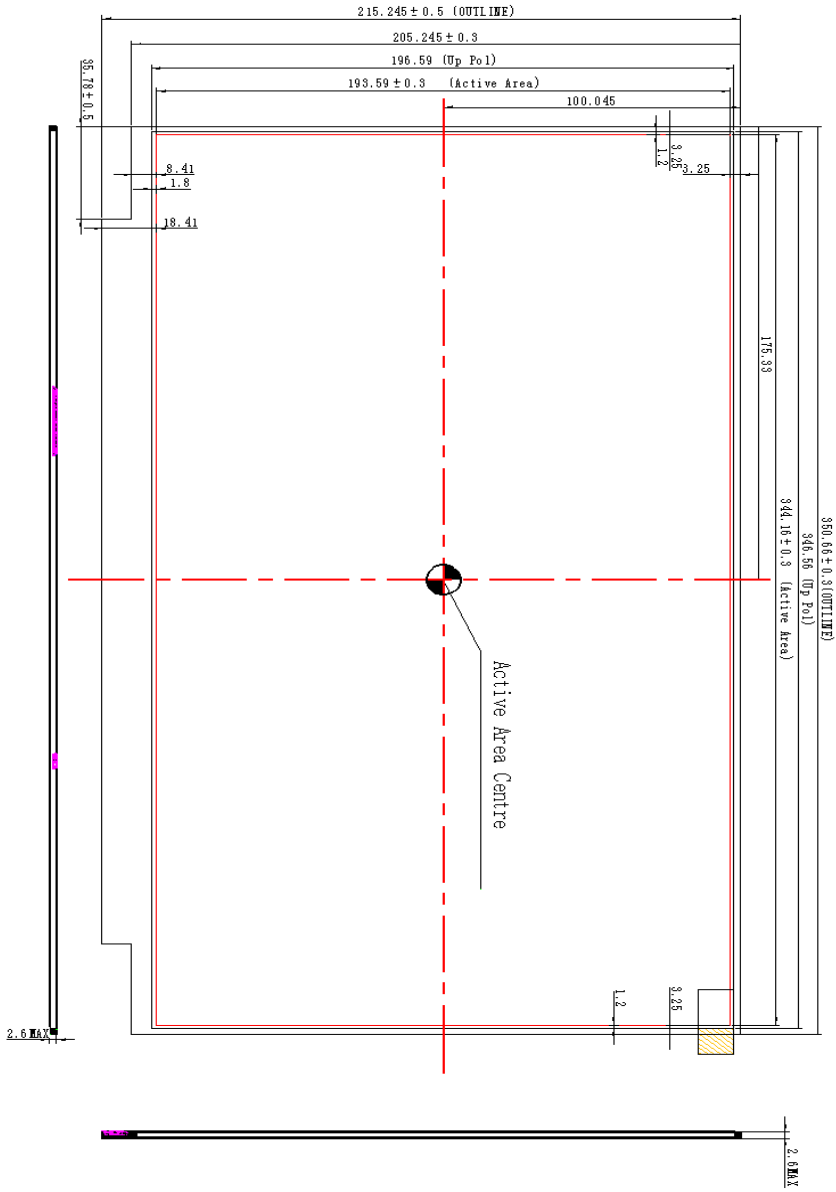

Figure 3. MDL OUTLINE

PRODUCT GROUP

REV

ISSUE DATE

TFT- LCD PRODUCT

P2

2018-03-01

SPEC. NUMBER

SPEC. TITLE

PAGE

AML156FHM-N4G V3.0 Product Specification

29 OF 33

Mechanical Drawing

Drawing Attachment: Back

NOTE
1. 翘曲度 $\leq 0.5\text{mm}$
2. Halogen Free & RoHS & REACH

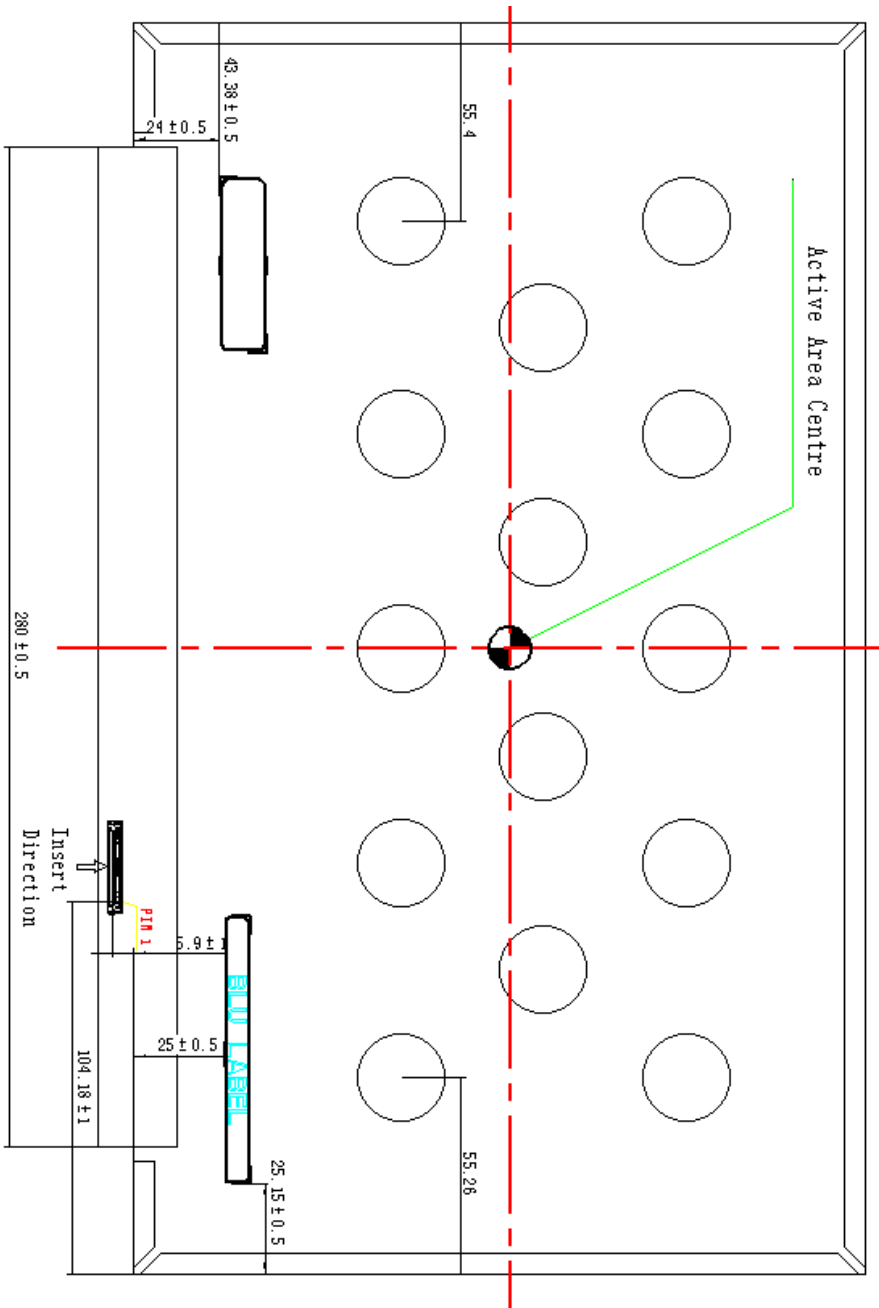

16.0 EDID Table

Address (HEX)	Function	Hex	Dec	Input values.	Notes
00	Header	00	0	0	EDID Header
01		FF	255	255	
02		FF	255	255	
03		FF	255	255	
04		FF	255	255	
05		FF	255	255	
06		FF	255	255	
07		00	0	0	
08	ID Manufacturer Name	09	9	BOE	ID = BOE
09		E5	229		
0A	ID Product Code	AF	175	1967	ID = 1967
0B		07	7		
0C	32-bit serial No.	00	0	0	
0D		00	0	0	
0E		00	0	0	
0F		00	0	0	
10	Week of manufacture	01	1	1	
11	Year of Manufacture	1C	28	2018	Manufactured in 2017
12	EDID Structure Ver.	01	1	1	EDID Ver 1.0
13	EDID revision #	04	4	4	EDID Rev. 0.4
14	Video input definition	A5	165	-	
15	Max H image size	22	34	34	34.416 cm (Approx)
16	Max V image size	13	19	19	19.359 cm (Approx)
17	Display Gamma	78	120	2.2	Gamma curve = 2.2
18	Feature support	02	2	-	RGB display, Preferred Timming mode
19	Red/Green low bits	4C	76	-	Red / Green Low Bits
1A	Blue/White low bits	30	48	-	Blue / White Low Bits
1B	Red x high bits	A4	164	0.642	Red (x) = 10100100 (0.642)
1C	Red y high bits	54	84	0.329	Red (y) = 01010100 (0.329)
1D	Green x high bits	51	81	0.316	Green (x) = 01010001 (0.316)
1E	Green y high bits	9B	155	0.606	Green (y) = 10011011 (0.606)
1F	Blue x high bits	27	39	0.153	Blue (x) = 00100111 (0.153)
20	Blue y high bits	0C	12	0.050	Blue (y) = 00001100 (0.050)
21	White x high bits	50	80	0.313	White (x) = 01010000 (0.313)
22	White y high bits	54	84	0.329	White (y) = 01010100 (0.329)
23	Established timing 1	00	0	-	
24	Established timing 2	00	0	-	

16.0 EDID Table

25	Established timing 3	00	0	-	
26	Standard timing #1	01	1		Not Used
27		01	1		
28	Standard timing #2	01	1		Not Used
29		01	1		
2A	Standard timing #3	01	1		Not Used
2B		01	1		
2C	Standard timing #4	01	1		Not Used
2D		01	1		
2E	Standard timing #5	01	1		Not Used
2F		01	1		
30	Standard timing #6	01	1		Not Used
31		01	1		
32	Standard timing #7	01	1		Not Used
33		01	1		
34	Standard timing #8	01	1		Not Used
35		01	1		
36	Detailed timing/mo nitor descriptor #1	9D	157	342.1	342.052MHz Main clock
37		85	133		
38		80	128	1920	Hor Active = 1920
39		A0	160	160	Hor Blanking = 160
3A		70	112	-	4 bits of Hor. Active + 4 bits of Hor. Blanking
3B		38	56	1080	Ver Active = 1080
3C		3E	62	62	Ver Blanking = 62
3D		40	64	-	4 bits of Ver. Active + 4 bits of Ver. Blanking
3E		6C	108	108	Hor Sync Offset = 108
3F		30	48	48	H Sync Pulse Width = 48
40		AA	170	10	V sync Offset = 10 line
41		00	0	10	V Sync Pulse width : 10 line
42		58	88	344	Horizontal Image Size = 344.16 mm (Low 8 bits)
43		C1	193	194	Vertical Image Size = 193.59 mm (Low 8 bits)
44		10	16	-	4 bits of Hor Image Size + 4 bits of Ver Image Si ze
45		00	0	0	Hor Border (pixels)
46		00	0	0	Vertical Border (Lines)
47		1A	26	-	Refer to right table

16.0 EDID Table

48	Detailed timing/monitor descriptor #2	CE	206	171	171.026MHz Main clock
49		42	66		
4A		80	128	1920	Hor Active = 1920
4B		A0	160	160	Hor Blanking = 160
4C		70	112	-	4 bits of Hor. Active + 4 bits of Hor. Blanking
4D		38	56	1080	Ver Active = 1080
4E		3E	62	62	Ver Blanking = 62
4F		40	64	-	4 bits of Ver. Active + 4 bits of Ver. Blanking
50		6C	108	108	Hor Sync Offset = 108
51		30	48	48	H Sync Pulse Width = 48
52		AA	170	10	V sync Offset = 10 line
53		00	0	10	V Sync Pulse width : 10 line
54		58	88	344	Horizontal Image Size = 344.16 mm (Low 8 bits)
55		C1	193	194	Vertical Image Size = 193.59 mm (Low 8 bits)
56		10	16	-	4 bits of Hor Image Size + 4 bits of Ver Image Size
57		00	0	0	Hor Border (pixels)
58		00	0	0	Vertical Border (Lines)
59	1A	26	-		
5A	Detailed timing/monitor descriptor #3	00	0	ASCII Data Sting Tag	
5B		00	0		
5C		00	0		
5D		FE	254		
5E		00	0		
5F		42	66	B	
60		4F	79	O	
61		45	69	E	
62	20	32		Manufacture name :AMELIN	
63	48	72	H		
64	46	70	F		
65	0A	10			
66	20	32			
67	20	32			
68	20	32			
69	20	32			
6A	20	32			
6B	20	32			

16.0 EDID Table

6C	Detailed timing/monitor descriptor #4	00	0		Product Name Tag (ASCII)
6D		00	0		
6E		00	0		
6F		FE	254		
70		00	0		
71		4E	78	N	Model name : AML156FHM-N4G
72		56	86	V	
73		31	49	1	
74		35	53	5	
75		36	54	6	
76		46	70	F	
77		48	72	H	
78		4D	77	M	
79		2D	45	-	
7A		4E	78	N	
7B		34	52	4	
7C	47	71	G		
7D	0A	10			
7E	Extension flag	00	0	1	0 : 1个EDID ; N-1:N个EDID
7F	Checksum	70	112	-	