

深圳市阿美林电子科技有限公司 Shenzhen Amelin Electronic Technology Co. Ltd		
	REV : A	PAGE : 1/21
SPEC TITLE DOCUMENT CONTROL SPECIFICATION	EFFECTIVE DATE : 2017-05-26	

Specifications

TFT-LCD module

Model No: AML-FRD090G08001-A

For Customer's Acceptance	
Approved by	Comment

	Signature	Date
Prepared by		
Checked by		
Approved by		

深圳市阿美林电子科技有限公司 Shenzhen Amelin Electronic Technology Co. Ltd		
	REV : A	PAGE : 2/21
SPEC TITLE DOCUMENT CONTROL SPECIFICATION	EFFECTIVE DATE : 2017-05-26	

Contents

No.	ITEM
1.	DOCUMENT REVISION HISTORY
2.	GENERAL DESCRIPTION
3.	OUTLINE DIMENSION
4.	TFT-LCM INTERFACE SPECIFICATION
5.	ABSOLUTE MAXIMUM RATINGS
6.	ELECTRICAL SPECIFICATIONS
7.	TIMING CHARACTERISTICS
8.	POWER SUPPLY CONFIGURATION
9.	OPTICAL SPECIFICATION
10.	RELIABILITY TEST ITEMS
11.	PACKAGE
12.	PRECAUTIONS
13.	INSPECTION STANDARD

深圳市阿美林电子科技有限公司 Shenzhen Amelin Electronic Technology Co. Ltd			
		REV : A	PAGE : 3/21
SPEC TITLE DOCUMENT CONTROL SPECIFICATION		EFFECTIVE DATE : 2017-05-26	

1. Document revision history :

DOCUMENT REVISION	DATE	DESCRIPTION	PREPARED BY	APPROVED BY
A	2017-06-02	First Release.		

深圳市阿美林电子科技有限公司 Shenzhen Amelin Electronic Technology Co. Ltd		
	REV : A	PAGE : 4/21
SPEC TITLE DOCUMENT CONTROL SPECIFICATION	EFFECTIVE DATE : 2017-05-26	

2.General Description

AML-FRD090G08001-A is a transmissive type a-Si TFT-LCD (amorphous silicon thin film transistor liquid crystal display) module, which is composed of a TFT-LCD panel, a driver circuit a backlight unit, The panel size is 0.9inch and the resolution is 80x160. High image quality a-Si TFT LCD module. Partial-screen display function is available. Sleep and Stand-by modes are available for power saving.

2.1 Features

No	Item	Specification	Remark
1	Display Mode	Normally Black	
2	Screen Size	0.9inch	
3	Resolution	80XRGBX160	
4	Color Number	262K	
5	Color Arrangement	TFT Active matrix	
6	Driver IC	ST7735S	
7	Back Light	White LED*1	
8	Viewing Direction	12 o'clock	
9	Interface	SPI	
10	Surface Treatment	UV Cut	
11	touch panel	-	

2.2 Application

- ◆ Mobile phone.
- ◆ Portable multimedia device.

3.Outline Dimension

The mechanical detail is shown in Fig. 1 and summarized in Table 1 below.

Parameter	Specifications	Unit
Outline dimensions	15.80(W) x27.00(H) x 1.66(D) (LCM, not include FPC)	mm
Active area	11.52(W) x20.16(H)	mm
Resolution	240(H)RGBx240(V) dots	-
Dot size	0.144(H) x 0.126(V)	mm

深圳市阿美林电子科技有限公司 Shenzhen Amelin Electronic Technology Co. Ltd	REV : A	PAGE : 5/21
	EFFECTIVE DATE : 2017-05-26	
SPEC TITLE DOCUMENT CONTROL SPECIFICATION		

Figure 1: Module specification of the module

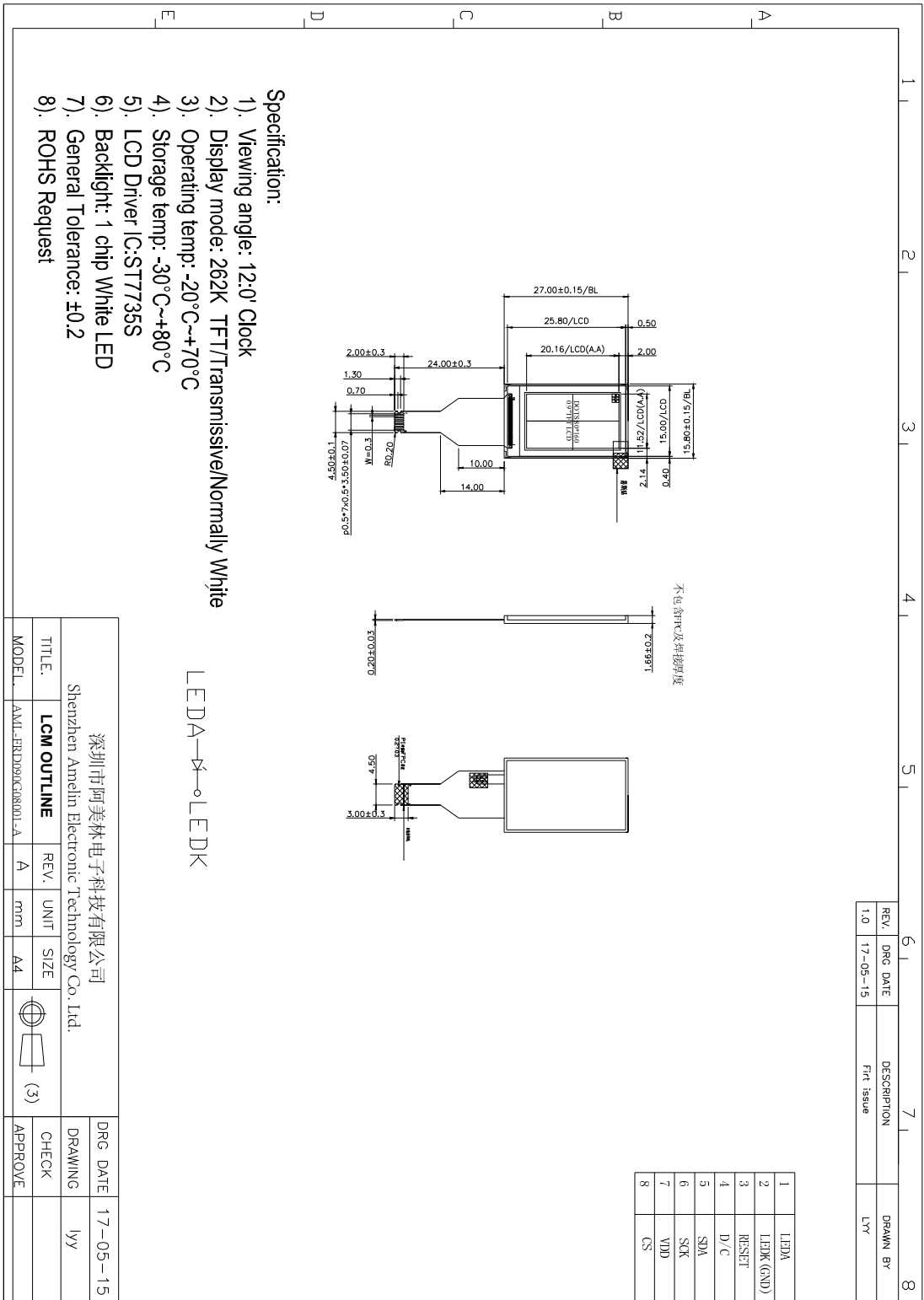

深圳市阿美林电子科技有限公司 Shenzhen Amelin Electronic Technology Co. Ltd		REV : A	PAGE : 6/21
SPEC TITLE DOCUMENT CONTROL SPECIFICATION		EFFECTIVE DATE : 2017-05-26	

4.TFT-LCM Interface Specification

Pin No	Symbol	Description	Note
1	LED_A	Power Supply For LED Backlight Anode Input	
2	LED_K	Power Supply For LED Backlight Cathode Input the System Ground	
3	RESET	Reset signal input Pin.	
4	D/C	Command/parameter or display data	
5	SDA	serial data input/output bi-direction pin	
6	SCK	Data or command select pin	
7	VDD	Power supply input for LCM: 2.8	
8	CS	Chip select input signal	

5. Absolute Maximum Ratings

5.1 Electrical Maximum Ratings – for IC Only

Table 3: Electrical Maximum Ratings – for IC

Parameter	Symbol	Min.	Max.	Unit	Note
Power supply voltage (VDD)	VDD	-0.3	+4.0	V	1
Power supply voltage (IOVCC)	IOVCC	-0.3	+3.6	V	1

Note:

- 1.IOVCC,VDD, GND must be maintained.
- 2.The modules may be destroyed if they are used beyond the absolute maximum ratings.

5.2 Environmental Condition

Table 4

Item	Operating temperature (Topr)		Storage temperature (Tstg) (Note 1)		Remark
	Min.	Max.	Min.	Max.	
Ambient temperature	-20°C	+70°C	-30°C	+80°C	Dry
Humidity (Note 1)	80% max. RH for Ta 40°C < 50% RH for 40°C < Ta Maximum operating temperature				No condensation

Note 1: Product cannot sustain at extreme storage conditions for long time.

深圳市阿美林电子科技有限公司 Shenzhen Amelin Electronic Technology Co. Ltd		REV : A	PAGE : 7/21
SPEC TITLE DOCUMENT CONTROL SPECIFICATION		EFFECTIVE DATE : 2017-05-26	

6. Electrical Specifications

Typical Electrical Characteristics

At $T_a = 25\text{ }^\circ\text{C}$, $V_{DD} = 2.6\text{V to }3.3\text{V}$, $IOVCC = 1.65\text{V to }3.3\text{V}$ $GND = 0\text{V}$.

Parameter	Symbol	Conditions	Min.	Typ.	Max.	Unit
Supply voltage (analog)	VDD-GND		2.6	2.8	3.3	V
Supply voltage (logic)	IOVDD-GND		1.65	1.8	3.3	V
Supply current (Logic & LCD)	ICC	VCC=2.8V	-	-	10	mA
Supply voltage of white LED backlight	VLED =V(BL+)- V(BL-)	Forward current =20 mA	2.9	3.2	3.3	V
Luminance (on the module surface)		Number of LED dies = 1	-	110	-	cd/m ²

7. Timing Characteristics

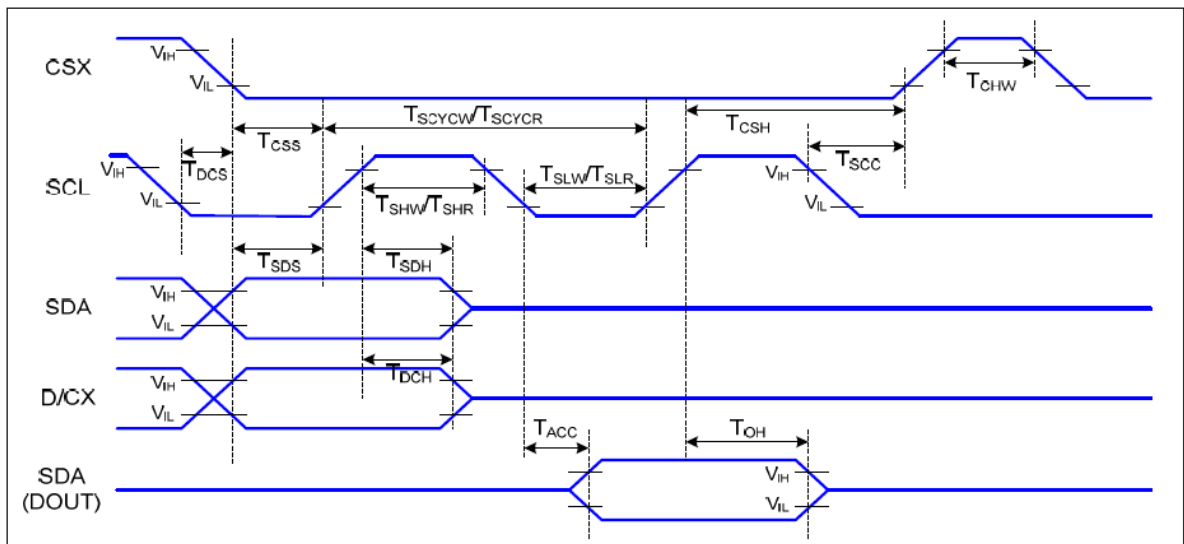

深圳市阿美林电子科技有限公司 Shenzhen Amelin Electronic Technology Co. Ltd		REV : A	PAGE : 8/21
SPEC TITLE DOCUMENT CONTROL SPECIFICATION		EFFECTIVE DATE : 2017-05-26	

Ta=25 °C, VDDI=1.65~3.7V, VDD=2.5~4.8V

Signal	Symbol	Parameter	MIN	MAX	Unit	Description
CSX	TCSS	Chip Select Setup Time (Write)	45		ns	
	TCSH	Chip Select Hold Time (Write)	45		ns	
	TCSS	Chip Select Setup Time (Read)	60		ns	
	TSCC	Chip Select Hold Time (Read)	65		ns	
	TCHW	Chip Select "H" Pulse Width	40		ns	
SCL	TSCYCW	Serial Clock Cycle (Write)	66		ns	-Write Command & Data Ram
	TSHW	SCL "H" Pulse Width (Write)	15		ns	
	TSLW	SCL "L" Pulse Width (Write)	15		ns	
	TSCYCR	Serial Clock Cycle (Read)	150		ns	-Read Command & Data Ram
	TSHR	SCL "H" Pulse Width (Read)	60		ns	
	TSLR	SCL "L" Pulse Width (Read)	60		ns	
D/CX	TDCS	D/CX Setup Time	10		ns	
	TDCH	D/CX Hold Time	10		ns	
SDA (DIN) (DOUT)	TSDS	Data Setup Time	10		ns	For Maximum CL=30pF For Minimum CL=8pF
	TSDH	Data Hold Time	10		ns	
	TACC	Access Time	10	50	ns	
	TOH	Output Disable Time	15	50	ns	

深圳市阿美林电子科技有限公司 Shenzhen Amelin Electronic Technology Co. Ltd		REV : A	PAGE : 9/21
SPEC TITLE DOCUMENT CONTROL SPECIFICATION		EFFECTIVE DATE : 2017-05-26	

8. Power Supply Configuration

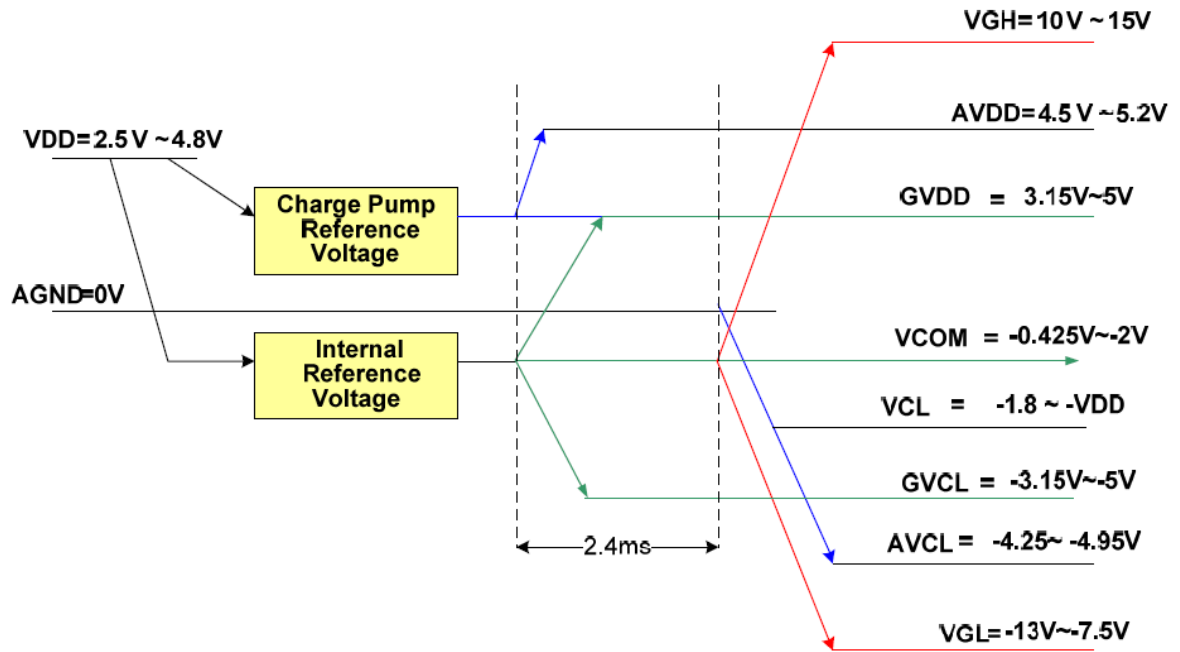

深圳市阿美林电子科技有限公司 Shenzhen Amelin Electronic Technology Co. Ltd		REV : A	PAGE : 10/21
SPEC TITLE DOCUMENT CONTROL SPECIFICATION		EFFECTIVE DATE : 2017-05-26	

9.Optical Specification

ITEM	SYMBOL	CONDITION	MIN.	TYP.	MAX.	
Color Filter Chromaticity	White	x	$\theta = \phi = 0^\circ$	0.291	0.311	0.331
		y		0.314	0.334	0.354
	Red	x	$\theta = \phi = 0^\circ$	0.624	0.644	0.664
		y		0.312	0.332	0.352
	Green	x	$\theta = \phi = 0^\circ$	0.278	0.298	0.318
		y		0.582	0.602	0.622
	Blue	x	$\theta = \phi = 0^\circ$	0.113	0.133	0.153
		y		0.101	0.121	0.141
	Gamut			66.68%		
	Measured by C light					
	Transmittance		$\theta = \phi = 0^\circ$	3.4%	3.9%	
	Measured by GP standard backlight					

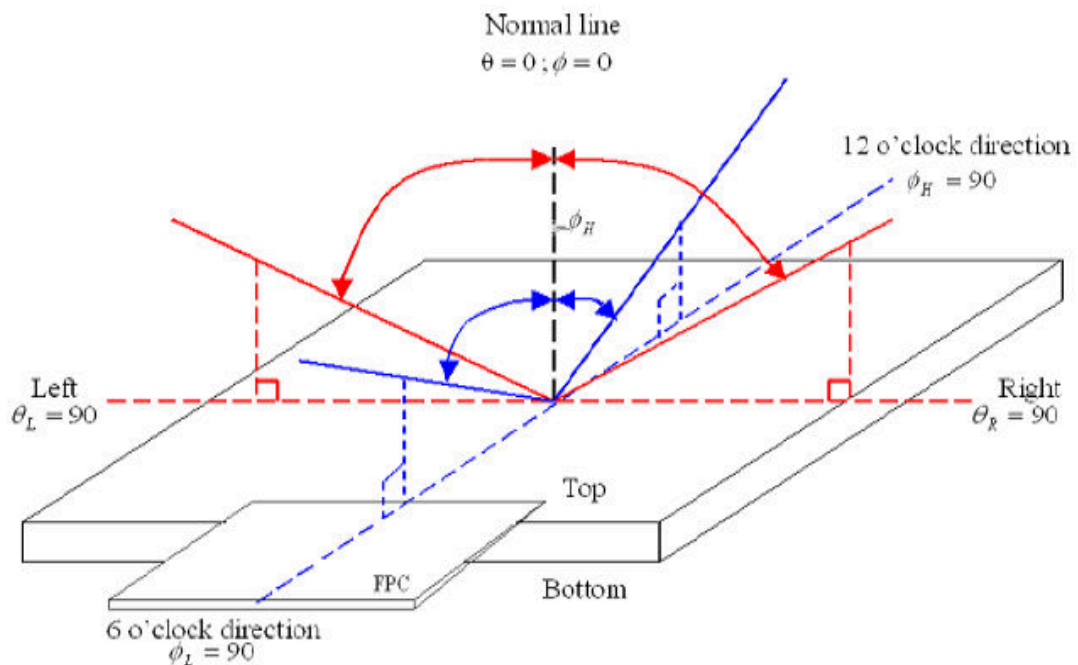

深圳市阿美林电子科技有限公司 Shenzhen Amelin Electronic Technology Co. Ltd		
	REV : A	PAGE : 11/21
SPEC TITLE DOCUMENT CONTROL SPECIFICATION	EFFECTIVE DATE : 2017-05-26	

Figure 4 Definition of Response Time

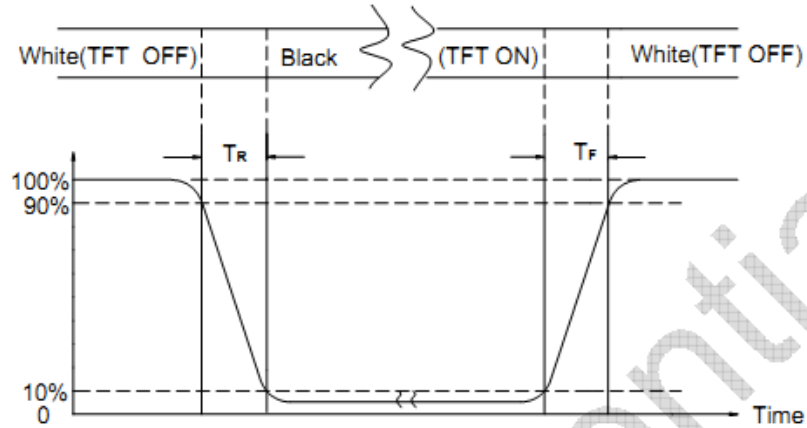

Note (5) Definition of Transmittance (Module is without signal input and IVO reference backlight).

$$\text{Transmittance} = \frac{\text{Luminance of LCD Module}}{\text{Luminance of Back light}} \times 100\%$$

Note (6) Reference C-light Spectrum

Figure 5 C-light Spectrum

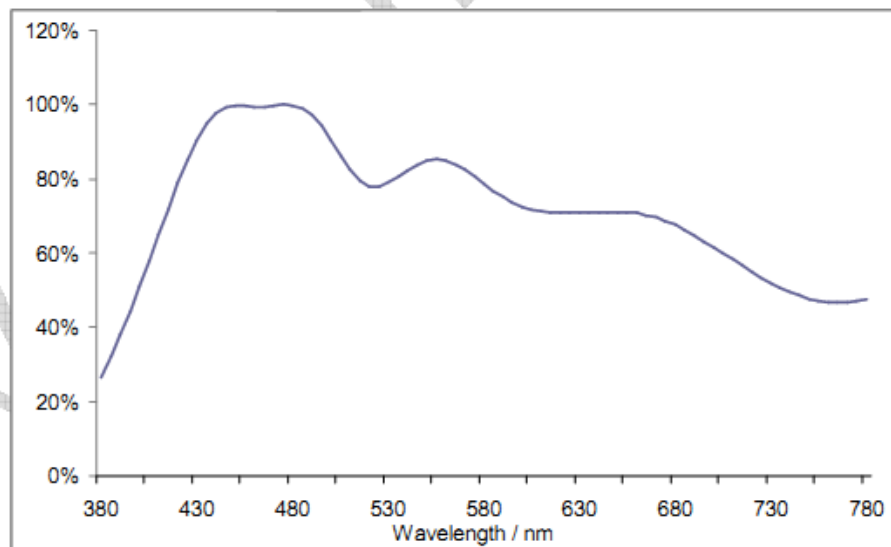

Note (7) The polarizer type: Samsung/CF, Samsung /Array.

Note (8) All optical data based on IVO given polarizer & C-light & testing machine in this document.

深圳市阿美林电子科技有限公司 Shenzhen Amelin Electronic Technology Co. Ltd		REV : A	PAGE : 12/21
SPEC TITLE DOCUMENT CONTROL SPECIFICATION		EFFECTIVE DATE : 2017-05-26	

10. Reliability Test Items

Item	Test Condition		Criterion
High Temperature Storage	80 °C, 120 hrs		There should be no change which might affect the practical display function when the display quality test is conducted under normal operating condition.
Low Temperature Storage	-30 °C, 120 hrs		
High Temp. & High Humidity Storage	60 °C, 90% RH, 120 hrs		
Vibration Test (Non-operating)	Freq.:10~55~10 Hz, Amp.:1.5mm 1 hr for each direction of X, Y, Z		
Electrostatic Discharge Test (Non-operating)	Terminals	150 pF, 0 Ω, ±300 V, Contact	
	Panel	150 pF, 330 Ω, ±8 KV, Air	
Thermal Shock (Static)	-30°C, 30 min /80°C, 30 min, 20 cycles		
High Temperature Operation	70 °C, 120 hrs		
Low temperature Operation	-20 °C, 120 hrs		
High Temperature & High Humidity (Operating)	50 °C, 90% RH, 120 hrs		
FPC Peeling Strength Test	Pull speed: 50 mm/min, +90°,		

深圳市阿美林电子科技有限公司 Shenzhen Amelin Electronic Technology Co. Ltd	REV : A	PAGE : 13/21
	SPEC TITLE DOCUMENT CONTROL SPECIFICATION	

11. Package

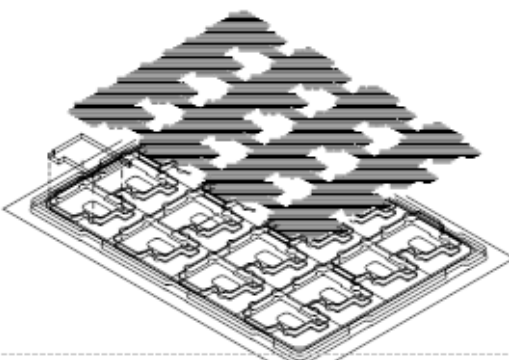
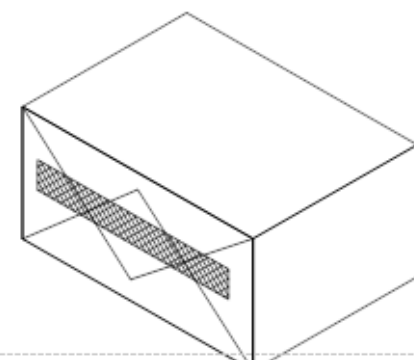
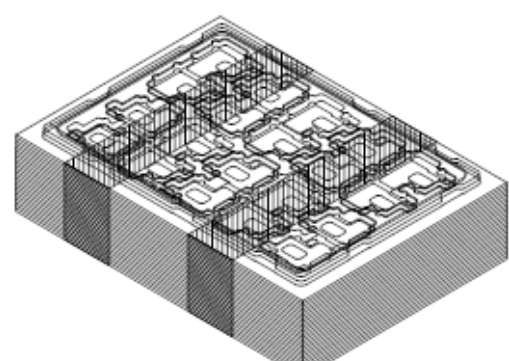
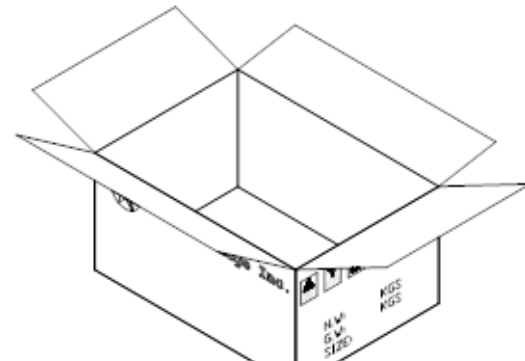
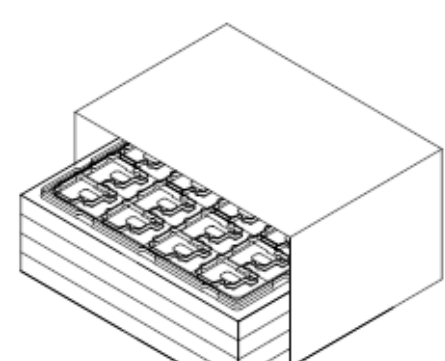
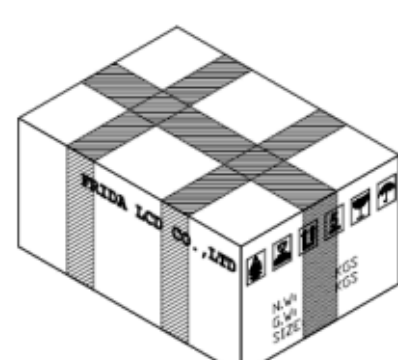
<p>1</p>  <p>16 pcs per tray + 1 cover (EPE)</p>	<p>4</p>  <p>Packing bag</p>
<p>2</p>  <p>25 trays + 1 dummy tray = 400 ps</p>	<p>5</p>  <p>Putting bag into carton Protected by 6 pieces of cushion EPE sheet</p>
<p>3</p>  <p>Putting trays into anti-electrostatic bag</p>	<p>6</p> 

深圳市阿美林电子科技有限公司 Shenzhen Amelin Electronic Technology Co. Ltd		
	REV : A	PAGE : 14/21
SPEC TITLE DOCUMENT CONTROL SPECIFICATION	EFFECTIVE DATE : 2017-05-26	

12.Precautions

Please pay attentions to the followings as using the LCD module.

Handling

- (a) Do not apply strong mechanical stress like drop, shock or any force to LCD module. It may cause improper operation, even damage.
- (b) Because the polarizer is very fragile and easy to be damaged, do not hit, press or rub the display surface with hard materials.
- (c) Do not put heavy or hard material on the display surface, and do not stack LCD modules.
- (d) If the display surface is dirty, please wipe the surface softly with cotton swab or clean cloth.
- (e) Avoid using Ketone type materials (e.g. Acetone), Toluene, Ethyl acid or Methyl chloride to clean the display surface. It might damage the touch panel surface permanently. The recommended solvents are water and Isopropyl alcohol.
- (f) Wipe off water droplets or oil immediately.
- (g) Protect the LCD module from ESD. It will damage the LSI and the electronic circuit.
- (h) Do not touch the output pins directly with bare hands.
- (i) Do not disassemble the LCD module.
- (j) Do not lift the FPC of Touch Panel.

Storage

- (a) Do not leave the LCD modules in high temperature, especially in high humidity for a long time.
- (b) Do not expose the LCD modules to sunlight directly.
- (c) The liquid crystal is deteriorated by ultraviolet. Do not leave it in strong ultraviolet ray for a long time.
- (d) Avoid condensation of water. It may cause improper operation.
- (e) Please stack only up to the number stated on carton box for storage and transportation. Excessive weight will cause deformation and damage of carton box.

深圳市阿美林电子科技有限公司 Shenzhen Amelin Electronic Technology Co. Ltd		
	REV : A	PAGE : 15/21
SPEC TITLE DOCUMENT CONTROL SPECIFICATION	EFFECTIVE DATE : 2017-05-26	

Operation

- (a) When mounting or dismounting the LCD modules, turn the power off.
- (b) Protect the LCD modules from electric shock.
- (c) The Driver IC control algorithms stated above should always obeyed to avoid damaging the LSI and electronic circuit.
- (d) Be careful to avoid mixing up the polarity of power supply for backlight.
- (e) Absolute maximum rating specified above has to be always kept in any case. Exceeding it may cause non-recoverable damage of electronic components or, nevertheless, burning.
- (f) When a static image is displayed for a long time, remnant image is likely to occur.
- (g) Be sure to avoid bending the FPC to an acute shape, it might break FPC.
- (h) Most of the touch screens have air vent to equalize the inside air pressure to the outside one. The air vent must be open and liquid contact must be avoided as the liquid may be absorbed if the liquid is accumulated near the air vent.
- (i) For the fragility of ITO film, it should avoid to use too tapering pen as the input material.

Touch Panel Mounting Notes

- (a) If a cushion is used between bezel/housing and film must be choose as free as enough to absorb the expansion and contraction to avoid the distortion of film.
- (b) The cushion must be placed out of the Viewing Area.
- (c) Bezel/Housing edge must be posited between Key Area and Viewing Area. The edge enters the Key Area may cause unexpected input if the gap is too narrow or foreign particles like dusts exist between Bezel/Housing and ITO film.
- (d) Mounting example:

深圳市阿美林电子科技有限公司 Shenzhen Amelin Electronic Technology Co. Ltd		
	REV : A	PAGE : 16/21
SPEC TITLE DOCUMENT CONTROL SPECIFICATION	EFFECTIVE DATE : 2017-05-26	

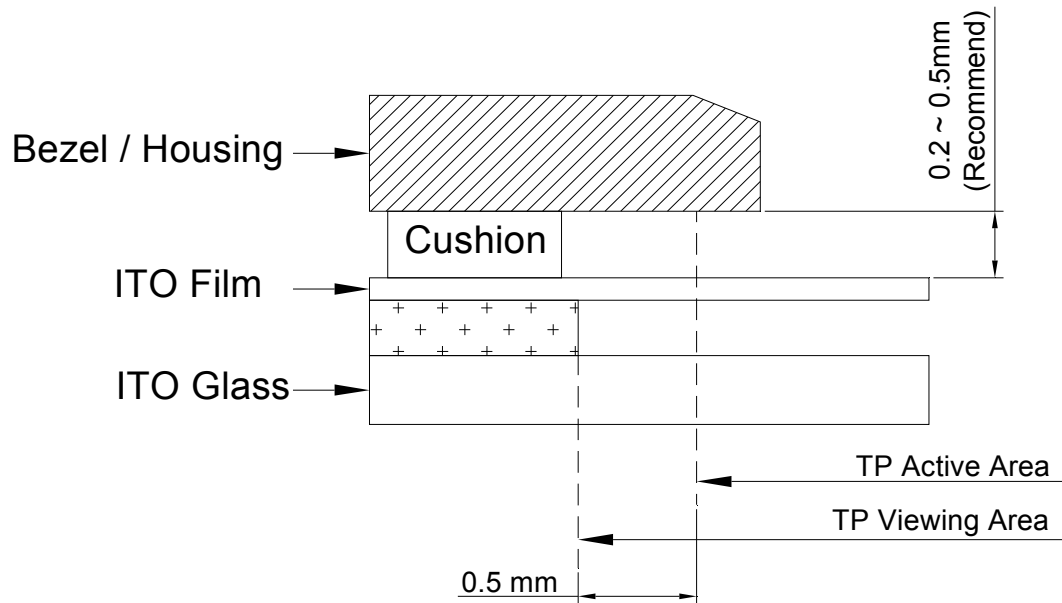

The corner part has conductivity. Do not touch any metal part after mounting.

Others

- a) If the liquid crystal leaks from the panel, it should be kept away from the eyes or mouth.
- b) For the fragility of polarizer, it is recommended to attach a transparent protective plate over the display surface.
- c) It is recommended to peel off the protection film on the polarizer slowly so that the electrostatic charge can be minimized.

深圳市阿美林电子科技有限公司 Shenzhen Amelin Electronic Technology Co. Ltd		REV : A	PAGE : 17/21
SPEC TITLE DOCUMENT CONTROL SPECIFICATION		EFFECTIVE DATE : 2017-05-26	

13. Inspection standard

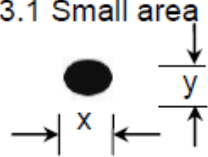
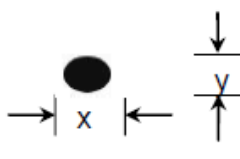
No	Item	Criterion										
01	Outline Dimension	In accord with drawing										
02	Position-finding Dimension Assemble Dimension	In accord with drawing										
03	LCD black spots, white spots (Round type)	Round type: non display 3.1 Small area LCD <div style="display: flex; align-items: center; margin-top: 10px;">  <table border="1" style="margin-left: 20px;"> <thead> <tr> <th colspan="2">Unit : mm</th> </tr> <tr> <th>Dimension</th> <th>Qualified Quantity</th> </tr> </thead> <tbody> <tr> <td>$D \leq 0.1$</td> <td>Ignore</td> </tr> <tr> <td>$0.1 < D \leq 0.15$</td> <td>2</td> </tr> <tr> <td>$D > 0.15$</td> <td>0</td> </tr> </tbody> </table> </div>	Unit : mm		Dimension	Qualified Quantity	$D \leq 0.1$	Ignore	$0.1 < D \leq 0.15$	2	$D > 0.15$	0
		Unit : mm										
Dimension	Qualified Quantity											
$D \leq 0.1$	Ignore											
$0.1 < D \leq 0.15$	2											
$D > 0.15$	0											
3.2 Large area LCD <div style="display: flex; align-items: center; margin-top: 10px;">  <table border="1" style="margin-left: 20px;"> <thead> <tr> <th>Dimension</th> <th>Qualified Quantity</th> </tr> </thead> <tbody> <tr> <td>$D \leq 0.1$</td> <td>Ignore</td> </tr> <tr> <td>$0.1 < D \leq 0.15$</td> <td>2</td> </tr> <tr> <td>$0.15 < D \leq 0.20$</td> <td>1</td> </tr> <tr> <td>$D > 0.20$</td> <td>0</td> </tr> </tbody> </table> </div> <p>C-STN : if $D > 0.1$, unqualified</p>	Dimension	Qualified Quantity	$D \leq 0.1$	Ignore	$0.1 < D \leq 0.15$	2	$0.15 < D \leq 0.20$	1	$D > 0.20$	0		
Dimension	Qualified Quantity											
$D \leq 0.1$	Ignore											
$0.1 < D \leq 0.15$	2											
$0.15 < D \leq 0.20$	1											
$D > 0.20$	0											

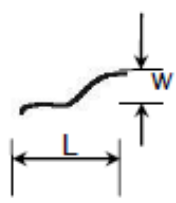
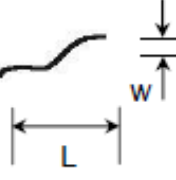
04	LCD black spots, white spots (Line Style)	Unit : mm	4.1 Small area LCD																	
			<table border="1" style="width:100%; border-collapse: collapse;"> <thead> <tr> <th style="text-align: center;">Length</th> <th style="text-align: center;">Width</th> <th style="text-align: center;">Qualified Quantity</th> </tr> </thead> <tbody> <tr> <td style="text-align: center;">-</td> <td style="text-align: center;">≤ 0.015</td> <td style="text-align: center;">Ignore</td> </tr> <tr> <td style="text-align: center;">≤ 1.0</td> <td style="text-align: center;">$0.015 < W \leq 0.025$</td> <td style="text-align: center;">2</td> </tr> <tr> <td style="text-align: center;">≤ 2.0</td> <td style="text-align: center;">$0.025 < W \leq 0.05$</td> <td style="text-align: center;">1</td> </tr> <tr> <td style="text-align: center;">≤ 1.0</td> <td style="text-align: center;">$0.025 < W \leq 0.05$</td> <td style="text-align: center;">1</td> </tr> <tr> <td style="text-align: center;">-</td> <td style="text-align: center;">$D > 0.05$</td> <td style="text-align: center;">According to circle</td> </tr> </tbody> </table>	Length	Width	Qualified Quantity	-	≤ 0.015	Ignore	≤ 1.0	$0.015 < W \leq 0.025$	2	≤ 2.0	$0.025 < W \leq 0.05$	1	≤ 1.0	$0.025 < W \leq 0.05$	1	-	$D > 0.05$
Length	Width	Qualified Quantity																		
-	≤ 0.015	Ignore																		
≤ 1.0	$0.015 < W \leq 0.025$	2																		
≤ 2.0	$0.025 < W \leq 0.05$	1																		
≤ 1.0	$0.025 < W \leq 0.05$	1																		
-	$D > 0.05$	According to circle																		
		4.2 Large area LCD																		
			<table border="1" style="width:100%; border-collapse: collapse;"> <thead> <tr> <th style="text-align: center;">Length</th> <th style="text-align: center;">Width</th> <th style="text-align: center;">Qualified Quantity</th> </tr> </thead> <tbody> <tr> <td style="text-align: center;">-</td> <td style="text-align: center;">≤ 0.015</td> <td style="text-align: center;">Ignore</td> </tr> <tr> <td style="text-align: center;">≤ 2.0</td> <td style="text-align: center;">$0.015 < W \leq 0.025$</td> <td style="text-align: center;">2</td> </tr> <tr> <td style="text-align: center;">≤ 1.0</td> <td style="text-align: center;">$0.025 < W \leq 0.05$</td> <td style="text-align: center;">1</td> </tr> <tr> <td style="text-align: center;">-</td> <td style="text-align: center;">$D > 0.05$</td> <td style="text-align: center;">According to circle</td> </tr> </tbody> </table>	Length	Width	Qualified Quantity	-	≤ 0.015	Ignore	≤ 2.0	$0.015 < W \leq 0.025$	2	≤ 1.0	$0.025 < W \leq 0.05$	1	-	$D > 0.05$	According to circle		
Length	Width	Qualified Quantity																		
-	≤ 0.015	Ignore																		
≤ 2.0	$0.015 < W \leq 0.025$	2																		
≤ 1.0	$0.025 < W \leq 0.05$	1																		
-	$D > 0.05$	According to circle																		
			CSTN : If $W \geq 0.015$, unqualified Ignore beyond viewing area																	
05	LCD Scratch 、 Threadlike Fiber	Same to NO.3 circle sightline and surface of LCD is vertical (2)Same to NO.3 line style																		
06	POL	It is not admissible that POL is beyond the edge of glass, else, unqualified. It is essential that POL is over the 50 percent of width of frame , else ,unqualified. According to the drawing in case of special definition.																		
07	IC/FPC Bonding	Scratch	Reject																	

深圳市阿美林电子科技有限公司 Shenzhen Amelin Electronic Technology Co. Ltd.		REV : A	PAGE : 19/21
SPEC TITLE DOCUMENT CONTROL SPECIFICATION		EFFECTIVE DATE : 2017-05-26	

		Intensity Of Adhesion	If lower than specification, reject	
		Gold Fold Twist	Reject	
07	IC/FPC Bonding	Silicon	According to outline, no gold outside, seal can not be higher than LCD	
		FPC Gold Sever	Reject	
08	SMT	Lack of Component、Polarity Inverse	If exist, reject	
		Leak Solder、Virtual Solder	If exist, reject	
		Short Circuit In Solder Point	If exist, reject	
		Tin Ball	If exist, reject	
		Tin Acumination	If visual, reject	
		Height Solder Point	If higher 0.5mm than component. reject	
		Height of component	Either side higher 0.5mm than component, reject	

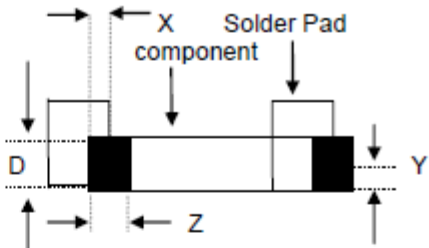
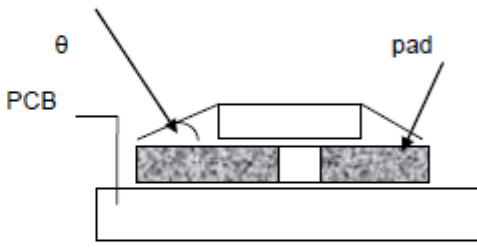
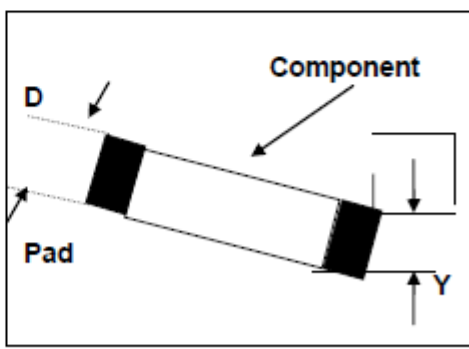
		Component Shift	 <p> $X < 3/4Z$ reject $y > 1/3D$ reject </p>
08	SMT	Few Tin	 <p>If $\theta \leq 20^\circ$ reject</p>
		Component Deflection	 <p>If $Y > 1/3D$ reject</p>
		Component Carcass Sideways	Reject

深圳市阿美林电子科技有限公司 Shenzhen Amelin Electronic Technology Co. Ltd		REV : A	PAGE : 21/21
SPEC TITLE DOCUMENT CONTROL SPECIFICATION		EFFECTIVE DATE : 2017-05-26	

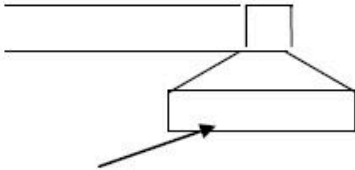
		Component Carcass Sideways	If exist with visual inspection , reject		
		Lot Tin	A: Tin accrete the solder side completely , hollowly ,Ok B: Tin accrete the solder side completely , full circle arc , ok C: Jointing include whole solder side, height of tin>50 percent of height of component, reject		
		Few Tin	A: Tin accrete the solder side completely , hollowly ,Ok B: height of tin > 1/3 of solder side of component , ok C: height of tin ≤ 1/3 of solder side of component, reject		
08	SMT	<p style="text-align: center;">Normal</p>  <p style="text-align: center;">Jointing side</p>			
		Short circuit , Open circuit	Forbid		
09	Light	Quality of CSTN Display	1、Rolling strake with visual inspection, forbid 2、Differentness of color in viewing area with visual inspection (full white、 red、 green、 blue), forbid 3 、 Display change with visual inspection , forbid		